

Overview

[fShape the Future of QuickSpecs - Your Input Matters](#)

HPE ProLiant DL365 Gen11 QuickSpecs

The new HPE ProLiant DL365 Gen11 server is a rack-optimized 1U 2P dense solution that delivers exceptional compute performance, enhanced data transfer rates, and increased memory capacity for 2P configurations.

Powered by 5th Generation AMD EPYC™ Processors with up to 160 cores, increased memory bandwidth (up to 6 TB). It also features high-speed PCIe Gen5 I/O, the HPE ProLiant DL365 Gen11 server is a superb rack-optimized, 1U 2P, dense solution.

The silicon root of trust anchors the server firmware to an HPE-exclusive ASIC, creating an immutable fingerprint for the AMD Secure Processor that must be matched exactly before the server boots.

The HPE ProLiant DL365 Gen11 server is an excellent choice for those who require increased compute density with built-in security and flexibility. A scalable, compute dense solution for high performance workloads such as general-purpose virtualization, Virtual Desktop Infrastructure (VDI), Electronic Design Automation (EAD) or Compute-Aided Design (CAD) and more.

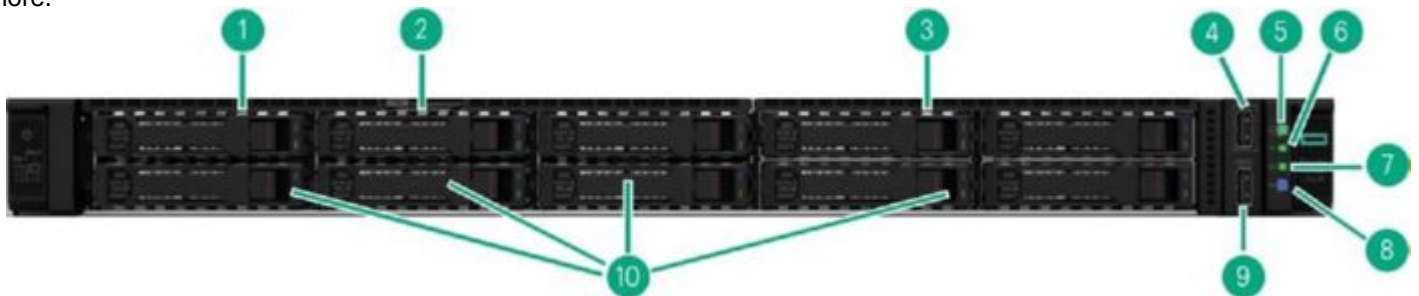

8 SFF Front View - 8 SFF & No Media Option Shown

Item	Description	Item	Description
1.	Quick removal access panel	6.	Health LED
2.	Serial no. label pull tab	7.	NIC status LED ¹
3.	Optional Media Bay*	8.	UID button LED
4.	HPE iLO service port	9.	USB 3.2 Gen 1 port
5.	Power On/Standby button and system power LED	10.	8 SAS/SATA/NVMe drive bays

Notes:

Optional: +2 SFF U.3 Tri-mode drive cage (total max 10 SFF).

Optional: 9.5mm SATA DVD-ROM/RW Optical Drive.

¹ Front NIC LED display does not support NIC LED ACT/LINK indication from ALOM/PCIE/FLOM NICs.

Overview

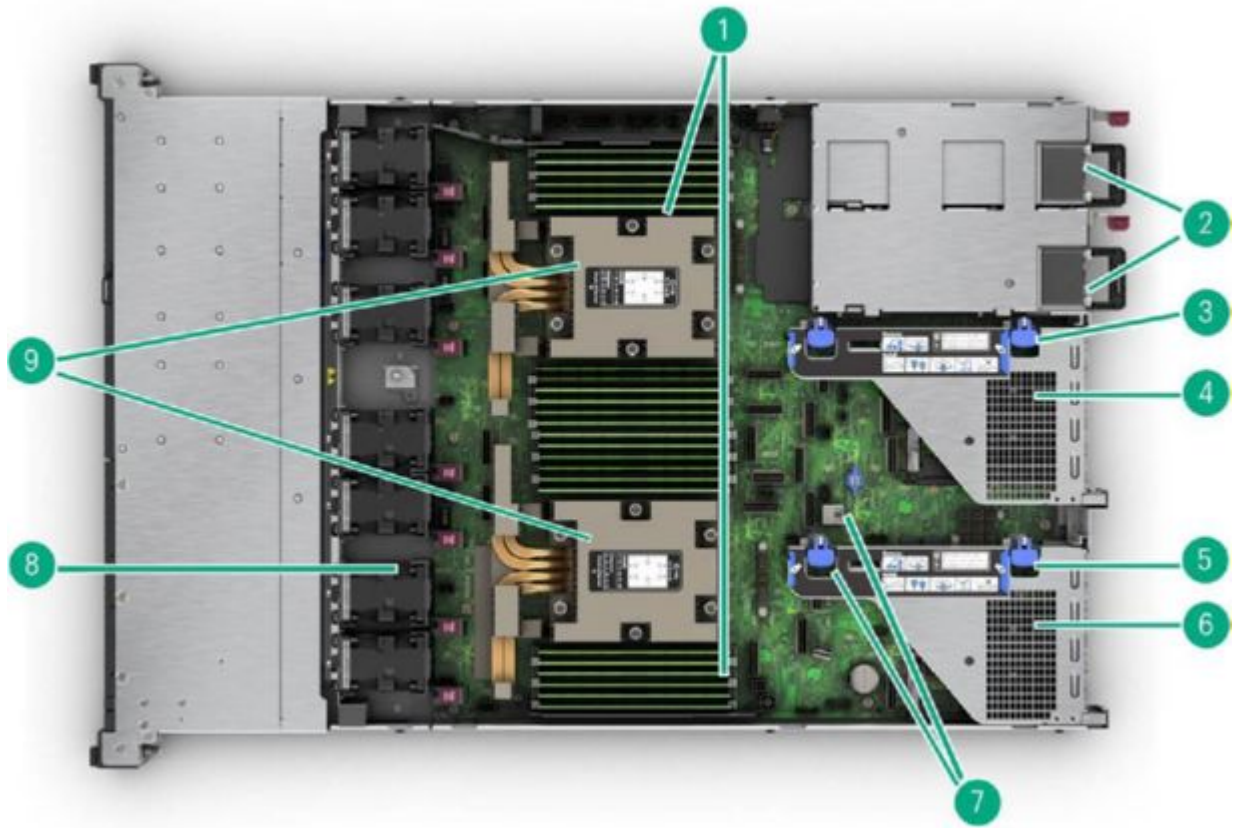

Internal View

Item	Description	Item	Description
1.	DDR5 DIMM slots. Shown populated in 24 slots	6.	(Under) OCP 3.0 Slot 1
2.	Hot-plug redundant HPE Flexible Slot Power supplies	7.	2x USB 3.2 Gen 1 ports
3.	Secondary Riser connector cage, optional	8.	Fan cage shown with 7 High Performance Fans
4.	(Under) OCP 3.0 Slot 2	9.	2 Processors (heatsinks shown)
5.	Primary PCIe riser cage, standard		

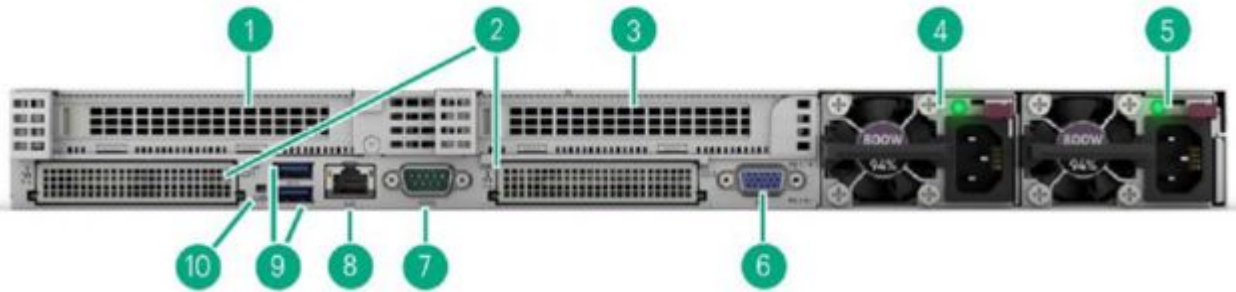

Rear View - Standard for all DL365 Gen11

Item	Description	Item	Description
1.	Slot 1 PCIe 5.0	6.	VGA port
2.	OCP 3.0 Slots	7.	Serial port (optional)
3.	Slot 2 PCIe 5.0	8.	Dedicated iLO management port
4.	Hot-plug Power Supply 2	9.	USB 3.2 Gen 1 ports
5.	Hot-plug Power Supply 1	10.	UID LED

Overview

What's New

- Supports the 5th and 4th Generation AMD EPYC™ Processors that support up to 160 cores.
 - 12 DIMM channels per processor for up to 6TB total DDR5 memory now supports 6400MT/s (5th Gen AMD EPYC™ CPUs).
 - New CTO servers include 8SFF, 20 EDSFF, and GPU CTO servers.
 - Supports up to 2x Single Width or 2x Double Width GPU cards at the front chassis.
 - NVIDIA A16 and NVIDIA L4 GPUs added.
 - Direct Liquid Cooling (DLC) is now supported.
 - 96GB, 128GB, and 256GB DDR5 RDIMM is now supported.
 - Advanced data transfer rate and higher network speed from the PCIe Gen5 serial expansion bus.
 - Includes HPE Integrated Lights-Out 6 (iLO 6) server management software.
 - Supports hot-pluggable, high-availability RAID M.2 boot options.
 - OpenBMC Capable through iLO6 Transfer of Ownership Process.
-

Standard Features

Platform Information

Form Factor

- 1U rack.

Chassis Types

- 8 SFF with optional optical drive kit, and optional SFF or NVMe drive bay options.
- 20 EDSFF drive bay.
- 2 Single Width or 2 Double Width GPUs with 8 EDSFF or 4SFF U.3 NVMe drive bay.

System Fans

- Choice of Standard Fan Kit and Performance Fan Kit. One fan per kit.
- 2 CPUs

- o Standard fan kits should be supported when the processors are equal to or lower than cTDP 240W.
- o Performance fan kits should be supported when the processors are higher than cTDP 240W.
- o Performance fan kits should be required when drive is NVMe or SAS4 drives.
- o Performance fan kits should be required when 10 SFF SAS/SATA/NVMe is configured.
- o Performance fan kits should be required when EDSFF or GPU CTO Servers are configured.

Notes:

- The DL365 Gen11 supports up to 7 fans with fan redundancy built in. One fan rotor failure will place server in degraded mode but fully functional. Two fan rotor failures could trigger warning and imminent server shutdown.
- Each Fan kit is designated to operate under different configurations. For more information, please refer to the Cooling option message in the Unique option section.

Processors Up to 2 of the following depending on model.

Notes: For more information regarding AMD EPYC™ processors, refer to the following:

<https://www.amd.com/en/products/processors/server/epyc.html>

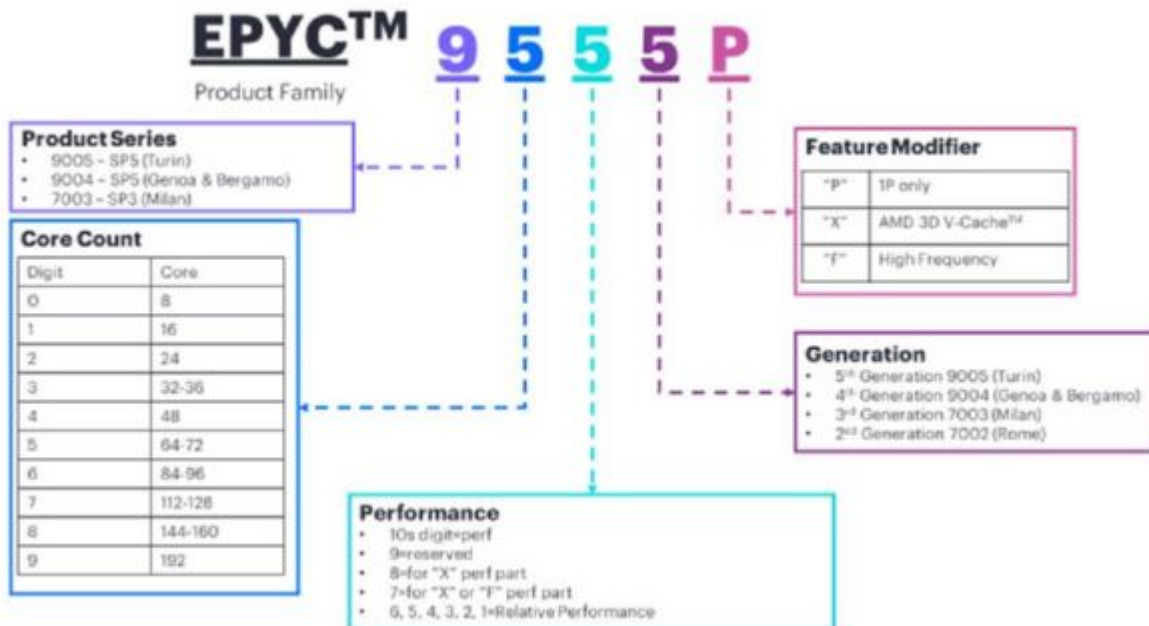

Standard Features

5 th Gen AMD EPYC™ Processor	Cores	Base Frequency	Max Frequency	Max Memory	Wattage	Cache	Memory
EPYC 9015	8	3.6 GHz	4.1 GHz	3 TB	125 W	64 MB	6400 MT/s
EPYC 9135	16	3.65 GHz	4.3 GHz	3 TB	200 W	64 MB	6400 MT/s
EPYC 9175F	16	4.2 GHz	5.0 GHz	3 TB	320 W	512 MB	6400 MT/s
EPYC 9115	16	2.6 GHz	4.1 GHz	3 TB	125 W	64 MB	6400 MT/s
EPYC 9255	24	3.2 GHz	4.3 GHz	3 TB	200 W	128 MB	6400 MT/s
EPYC 9275F	24	4.1 GHz	4.8 GHz	3 TB	320 W	256 MB	6400 MT/s
EPYC 9355	32	3.55 GHz	4.4 GHz	3 TB	280 W	256 MB	6400 MT/s
EPYC 9375F	32	3.8 GHz	4.8 GHz	3 TB	320 W	256 MB	6400 MT/s
EPYC 9335	32	3.0 GHz	4.4 GHz	3 TB	210 W	128 MB	6400 MT/s
EPYC 9365	36	3.4 GHz	4.3 GHz	3 TB	300 W	192 MB	6400 MT/s
EPYC 9475F	48	3.65 GHz	4.8 GHz	3 TB	400 W	256 MB	6400 MT/s
EPYC 9455	48	3.15 GHz	4.4 GHz	3 TB	300 W	256 MB	6400 MT/s
EPYC 9555	64	3.2 GHz	4.4 GHz	3 TB	360 W	256 MB	6400 MT/s
EPYC 9575F	64	3.3 GHz	5.0 GHz	3 TB	400 W	256 MB	6400 MT/s
EPYC 9535	64	2.4 GHz	4.3 GHz	3 TB	300 W	256 MB	6400 MT/s
EPYC 9565	72	3.15 GHz	4.3 GHz	3 TB	400 W	384 MB	6400 MT/s
EPYC 9655	96	2.6 GHz	4.5 GHz	3 TB	400 W	384 MB	6400 MT/s
EPYC 9645	96	2.3 GHz	3.7 GHz	3 TB	320 W	256 MB	6400 MT/s
EPYC 9745	128	2.4 GHz	3.7 GHz	3 TB	400 W	256 MB	6400 MT/s
EPYC 9825	144	2.2 GHz	3.7 GHz	3 TB	390 W	384 MB	6400 MT/s
EPYC 9845	160	2.1 GHz	3.7 GHz	3 TB	390 W	320 MB	6400 MT/s

4 th Gen AMD EPYC™ Processor	Cores	Base Frequency	Max Frequency	Max Memory	Wattage	Cache	Memory
EPYC 9124	16	3.0 GHz	3.7 GHz	3 TB	200 W	64 MB	4800 MT/s
EPYC 9174F	16	4.1 GHz	4.4 GHz	3 TB	320 W	256 MB	4800 MT/s
EPYC 9184X	16	3.55 GHz	4.2 GHz	3 TB	320 W	768 MB	4800 MT/s
EPYC 9224	24	2.5 GHz	3.7 GHz	3 TB	200 W	64 MB	4800 MT/s
EPYC 9254	24	2.9 GHz	4.15 GHz	3 TB	200 W	128 MB	4800 MT/s
EPYC 9274F	24	4.05 GHz	4.3 GHz	3 TB	320 W	256 MB	4800 MT/s
EPYC 9334	32	2.7 GHz	3.9 GHz	3 TB	210 W	128 MB	4800 MT/s
EPYC 9354	32	3.25 GHz	3.8 GHz	3 TB	280 W	256 MB	4800 MT/s
EPYC 9384X	32	3.1 GHz	3.9 GHz	3 TB	320 W	768 MB	4800 MT/s
EPYC 9374F	32	3.85 GHz	4.3 GHz	3 TB	320 W	256 MB	4800 MT/s
EPYC 9454	48	2.75 GHz	3.8 GHz	3 TB	290 W	256 MB	4800 MT/s
EPYC 9474F	48	3.6 GHz	4.1 GHz	3 TB	360 W	256 MB	4800 MT/s
EPYC 9534	64	2.45 GHz	3.7 GHz	3 TB	280 W	256 MB	4800 MT/s
EPYC 9554	64	3.1 GHz	3.75 GHz	3 TB	360 W	256 MB	4800 MT/s
EPYC 9634	84	2.25 GHz	3.7 GHz	3 TB	290 W	384 MB	4800 MT/s
EPYC 9654	96	2.4 GHz	3.7 GHz	3 TB	360 W	384 MB	4800 MT/s
EPYC 9684X	96	2.55 GHz	3.7 GHz	3 TB	400 W	1,150 MB	4800 MT/s
EPYC 9734	112	2.2 GHz	3.0 GHz	3 TB	340 W	256 MB	4800 MT/s
EPYC 9754	128	2.25 GHz	3.1 GHz	3 TB	360 W	256 MB	4800 MT/s

Standard Features

- Notes:
- 5th generation AMD EPYC™ 9005 processors now support 6400 MT/s
 - All 4th and 5th generation AMD EPYC™ processors can support up to 3TB of memory each under 1DPC, 12 channel per processor. 6 TB of memory per two processors.
 - 160 PCIe 5.0 lanes support with two sockets. Motherboard supports 3XGMI two-processor interconnected by default.
 - The wattage information indicates the default cTDP (Configurable TDP) of the processor.

Chipset

No chipset - System on Chip (SoC) design.

System Management Chipset
HPE iLO 6 ASIC.

Notes: [Read and learn more in the iLO QuickSpecs.](#)

Memory	
Type	HPE DDR5 Smart Memory, Registered (RDIMM)
DIMM Slots Available	24 12 DIMM slots per processor, 12 channels per processor, 1 DIMM per channel
Maximum capacity (RDIMM)	6.0 TB 24 x 256 GB RDIMM* @ 4800 MT/s at 1 DPC (4 th Generation AMD EPYC™ CPUs) 24 x 256 GB RDIMM* @ 6400 MT/s at 1 DPC (5 th Generation AMD EPYC™ CPUs)

- Notes:
- All processors support up to 3 TB of memory per server.
 - LRDIMM and Persistent Memory are not supported.
 - For additional information, refer to the [HPE DDR5 Smart Memory QuickSpecs](#).
 - For General Server Memory and Persistent Memory Population Rules and Guidelines, see details here: <http://www.hpe.com/docs/memory-population-rules>

Memory Protection

Advanced ECC

Advanced ECC uses single device data correction to detect and correct single and all multibit errors that occur within a single DRAM chip.

Online Spare

Memory online spare mode detects a rank that is degrading and switches operation to the spare rank.

Notes: [For more information see our Memory RAS feature technical whitepaper.](#)

Expansion Slots

Primary Riser					
Slots #	Technology	Bus Width	Connector Width	Slot Form Factor	Notes
1	PCIe 5.0	X16	X16	Full-height, Half-length slot	Proc 1
Secondary Riser					
Slots #	Technology	Bus Width	Connector Width	Slot Form Factor	Notes
2	PCIe 5.0	X16	X16	Full-height, Half-length slot	Proc 2
2	PCIe 5.0	X16	X16	Low Profile	Proc 2
GPU Riser 1					
Slots #	Technology	Bus Width	Connector Width	Slot Form Factor	Notes
4	PCIe 5.0	X16	X16	Full-height, Full-length slot	Proc 2
GPU Riser 2					
Slots #	Technology	Bus Width	Connector Width	Slot Form Factor	Notes
5	PCIe 5.0	X16	X16	Full-height, Full-length slot	Proc 1

Standard Features

Notes:

- Secondary riser position supports both Low Profile and FHHL cards. Only one can be supported at a time.
 - When NS204i-u Hot-plug Boot Optimized Storage Device is selected, low profile secondary riser (P55029-B21) must be in the configuration.
 - When both the Secondary Slot 2 & GPU Riser #1 Slot 4 are supported, Slot 2 & Slot 4 combined can support up to 112GB/s bandwidth due to processor limitations.
 - When both the GPU Riser #2 Slot 5 & Slot 21 (OCP1) are supported, Slot 5 & Slot 21 combined can support up to 112GB/s bandwidth due to processor limitations.
-

Storage Controllers

The Gen11 controller naming framework has been updated to simplify identification as depicted below. For a more detailed breakout of the available Gen11 Smart Array Controllers visit the controller data sheet.

NVMe Boot Device

- HPE NS204i-u Gen11 NVMe Hot-plug Boot Optimized Storage Device.

Notes:

- This kit does not occupy a PCIe slot.
- NS204i-u is externally accessible.
- NS204i-u includes embedded 2x 480GB NVMe SSD.
- RAID 1 is supported on the NS204i-u boot optimized storage device.

Software RAID

Software RAID is not supported on AMD Gen11 servers.

Essential RAID Controllers

- HPE Smart Array E208e-p SR Gen10 Controller.

Performance RAID Controllers

- HPE MR216i-p Gen11 x16 Lanes without Cache PCI SPDM Plug-in Storage Controller.
- HPE MR216i-o Gen11 x16 Lanes without Cache OCP SPDM Storage Controller.
- HPE MR408i-o Gen11 x8 Lanes 4GB Cache OCP SPDM Storage Controller.
- HPE MR416i-o Gen11 x16 Lanes 8GB Cache OCP SPDM Storage Controller.
- HPE MR416i-p Gen11 x16 Lanes 8GB Cache PCI SPDM Plug-in Storage Controller.
- HPE SR932i-p Gen11 x32 Lanes 8GB Wide Cache PCI SPDM Plug-in Storage Controller.

Notes:

- For additional details, please visit:

[HPE Compute MR Gen11 Controllers QuickSpecs](#)

[HPE Compute SR Gen11 Controllers QuickSpecs](#)

Standard Features

Graphics

Integrated Video Standard

- Video modes up to 1920 x 1200@60Hz (32 bpp).
- 16 MB Video Memory.

HPE iLO 6 on system management memory

- 64 MB Flash.
- 8 Gbit DDR 4 with ECC protection.

Internal Storage Devices

Optical Drive

- Available on 8 SFF CTO Servers as an option (DVD-ROM or DVD-RW).

Hard Drives

- None ship standard.

Maximum Storage

Storage	Capacity	Configuration
Hot-plug SFF SAS HDD	24 TB	(8+2) x 2.4 TB
Hot-plug SFF SATA HDD	20 TB	(8+2) x 2.0 TB
Hot-plug SFF SAS SSD	76.8 TB	(8+2) x 7.68 TB
Hot-plug SFF SATA SSD	76.8 TB	(8+2) x 7.68 TB
Hot-plug SFF NVMe PCIe U.3 SSD	153.6 TB	(8+2) x 15.36 TB

Power Supply

- HPE 800W Flex Slot Platinum Hot-plug Low Halogen Power Supply Kit.
- HPE 1600W Flex Slot Platinum Hot-plug Low Halogen Power Supply Kit.

Notes: Available in 94% Power Efficiency.

- HPE 1000W Flex Slot Titanium Hot-plug Power Supply Kit.

Notes: Available in 96% Power Efficiency.

- HPE 1600W Flex Slot -48VDC Hot-plug Power Supply Kit.

Notes:

– Available in 94% Power Efficiency.

– 200-240VAC power input only.

HPE Flexible Slot (Flex Slot) Power Supplies share a common electrical and physical design that allows for hot-plug, tool-less installation into HPE ProLiant Gen11 Servers. Flex Slot power supplies are certified for high-efficiency operation and offer multiple power output options, allowing users to "right-size" a power supply for specific server configurations. This flexibility helps to reduce power waste, lower overall energy costs, and avoid "trapped" power capacity in the data center.

All pre-configured servers ship with a standard 6-foot IEC C-13/C-14 jumper cord (A0K02A). This jumper cord is also included with each standard AC power supply option kit. If a different power cord is required, please check the [ProLiant Power Cables](#) web page.

To review the power requirements for your selected system, please use the [HPE Power Advisor Tool](#).

For information on power specifications and technical content visit [HPE Server power supplies](#).

Standard Features

Interfaces	
Serial Ports	1 port - Optional in rear
Video Ports	1 Rear VGA Port - Standard
Network Ports	None. Choice of OCP or stand-up card, supporting a wide range of NIC adapters
HPE iLO Remote Management Network Port	1 Gb Dedicated
Front iLO Service Port	1 standard
USB 3.2 Gen 1	Five standard on all models: one front, two rear, two internal
SID (Systems Insight Display)	Optional

Operating Systems and Virtualization Software Support for HPE Servers

HPE servers are designed for seamless integration with partner Operating Systems and Virtualization Software. By collaborating closely with our partners, we ensure that their products are optimized, certified, and fully supported within your HPE server environment.

Access the certified and supported servers for each of the OS and Virtualization software: [HPE Servers Support & Certification Matrices](#)

HPE Server UEFI

Unified Extensible Firmware Interface (UEFI) is an industry standard that provides better manageability and a more secure configuration than the legacy ROM while interacting with your server at boot time. HPE ProLiant Gen11 servers have a UEFI Class 3 implementation.

UEFI enables numerous new capabilities specific to HPE ProLiant servers such as

- Secure Boot and Secure Start enable enhanced security.
- Operating system specific functionality.
- Support for > 2.2 TB (using GPT) boot drives.
- USB 3.1 Gen 1 Stack.
- Embedded UEFI Shell.
- Mass Configuration Deployment Tool using iLO RESTful API that is Redfish API Conformant.
- PXE boot support for IPv6 networks.
- Workload Profiles for simple performance optimization.
- Embedded TPM Support.

UEFI Boot Mode only

- TPM 2.0 Support.
- NVMe Boot Support.
- iSCSI Software Initiator Support.
- HTTP/HTTPs Boot support as a PXE alternative.
- Boot support for option cards that only support a UEFI option ROM.

Notes:

- For UEFI Boot Mode, boot environment and OS image installations should be configured properly to support UEFI.
- Enabling TPM 2.0 no longer requires TPM module option kit on Gen11. It is an embedded feature.

Industry Standard Compliance

- ACPI 6.1 Compliant.
- PCIe 5.0 Compliant.
- WOL Support.
- Microsoft® Logo certifications.
- PXE Support.
- VGA/Display Port.
- USB 3.2 Gen 1 Compliant.
- USB 2.0 Compliant.
- ENERGY STAR® 4.0.
- SMBIOS 3.1.
- UEFI 2.7.
- UEFI Class 3.

Standard Features

- Redfish API.
- IPMI 2.0.
- Secure Digital 2.0.
- Advanced Encryption Standard (AES).
- Triple Data Encryption Standard (3DES).
- SNMP v3.
- TLS 1.2.
- DMTF Systems Management Architecture for Server Hardware Command Line Protocol (SMASH CLP).
- Active Directory v1.0.
- European Union (EU) eco-design regulations for server and storage products, known as Lot 9, go into effect on March 1st, 2020. Among other requirements, for servers this directive establishes power thresholds for idle state, as well as efficiency and performance in active state which vary among configurations. HPE ProLiant Gen11 servers are compliant with Lot9 requirements. For more information regarding HPE Lot 9 conformance, please visit: <https://www.hpe.com/us/en/about/environment/msds-specs-more.html>
- ASHRAE A3/A4.
- UEFI (Unified Extensible Firmware Interface Forum).
- APM 1.0.

Notes:

- ENERGY STAR® 4.0 is supported. Please configure P68503-B21 to trigger ENERGY STAR® 4.0
- For additional technical thermal details regarding ambient temperatures, humidity and features support please visit: https://support.hpe.com/hpesc/public/docDisplay?docId=sd00002260en_us&page=GUID-EFACB705-52C8-44E4-9ED9-C2B275676D5F.html

Embedded Management

HPE Integrated Lights-Out (HPE iLO)

Monitor your servers for ongoing management, service alerting, reporting and remote management with HPE iLO.

Learn more at: <http://www.hpe.com/info/ilo>

UEFI

Configure and boot your servers securely with industry standard Unified Extensible Firmware Interface (UEFI).

Learn more at: <http://www.hpe.com/servers/uefi>.

Intelligent Provisioning

Hassle free server and OS provisioning for 1 or more servers with Intelligent Provisioning.

Learn more at: https://support.hpe.com/connect/s/product?language=en_US&kmpmoid=5219984&tab=manuals

iLO RESTful API

iLO RESTful API is Redfish API conformance and offers simplified server management automation such as configuration and maintenance tasks based on modern industry standards. Learn more at: <http://www.hpe.com/info/restfulapi>.

OpenBMC Support

OpenBMC Capable through iLO6 Transfer of Ownership Process.

Learn more at [OpenBMC enablement on HPE ProLiant servers | HPE](#)

Standard Features

Server Utilities

Active Health System

The HPE Active Health System (AHS) is an essential component of the iLO management portfolio that provides continuous, proactive health monitoring of HPE servers. Learn more at: <http://www.hpe.com/servers/ahs>.

Smart Update

Keep your servers up to date with the HPE Smart Update solution by using Smart Update Manager (SUM) to optimize the firmware and driver updates of the Service Pack for ProLiant (SPP). Learn more at <https://www.hpe.com/servers/smart-update.html>

iLO Amplifier Pack

Designed for large enterprise and service provider environments with hundreds of HPE servers, the iLO Amplifier Pack is a free, downloadable open virtual application (OVA) that delivers the power to discover, inventory and update Gen8, Gen9, Gen10, Gen10 Plus, and Gen11 HPE servers. Use with an iLO Advanced License to unlock full capabilities.

Learn more at: <http://www.hpe.com/servers/iLOamplifierpack>.

RESTful Interface Tool

RESTful Interface tool (iLOREST) is a single scripting tool to provision using iLO RESTful API to discover and deploy servers at scale. Learn more at: <http://www.hpe.com/info/resttool>.

Scripting Tools

Provision one too many servers using your own scripts to discover and deploy with Scripting Tool (STK) for Windows and Linux or Scripting Tools for Windows PowerShell. Learn more at: <http://www.hpe.com/servers/powershell>.

HPE OneView Standard

HPE OneView is an on-premises, multi-generational server monitoring and management solution. HPE OneView Standard can be used for inventory, health monitoring, alerting, and reporting without additional fees. Customers can upgrade their management experience with an HPE OneView Advanced license, all provided by the same tool. Learn more at: <http://www.hpe.com/info/oneview>.

HPE Compute Ops Management

Transform compute lifecycle management with a cloud experience that delivers greater simplicity, agility, and speed across your entire server environment, wherever it lives. This software-as-a-service tool provides a dashboard with global visibility and intuitive management of server health, security and compliance status to help you easily identify areas that need immediate attention. Users can update tens to thousands of servers faster through intelligent delta-based firmware downloads and on-demand HPE iLO firmware updates.

HPE Compute Ops Management is cloud-native software that is continually updated with new services, features, patches, and firmware packs. The management application resides in GreenLake cloud (access via <https://common.cloud.hpe.com>) and leverages the GreenLake architecture, security, and unified operations.

For a complete list of software as-a-service subscription SKUs and more information, visit the HPE Compute Ops Management QuickSpecs: <https://www.hpe.com/psnow/doc/a50004263enw>

For information on supported HPE servers, the complete list can be found here: <https://www.hpe.com/info/com-supported-servers>

Security

- UEFI Secure Boot and Secure Start support.
 - Immutable Silicon Root of Trust.
 - FIPS 140-3 validation (iLO 6 certification in progress).
 - Common Criteria certification (iLO 6 certification in progress).
 - Configurable for PCI DSS compliance.
 - Advanced Encryption Standard (AES) and Triple Data Encryption Standard (3DES) on browser.
 - Support for Commercial National Security Algorithms (CNSA).
-

Standard Features

- Tamper-free updates - components digitally signed and verified.
- Secure Recovery - recover critical firmware to known good state on detection of compromised firmware.
- Ability to rollback firmware.
- Secure erase of NAND/User data.
- TPM (Trusted Platform Module) 2.0 option.
- Bezel Locking Kit option.
- Chassis Intrusion detection option

Notes: Enabling TPM 2.0 no longer requires TPM module option kit on Gen11. It is an embedded feature

Warranty

This product is covered by a global limited warranty and supported by HPE Services and a worldwide network of Hewlett Packard Enterprise Authorized Channel Partners resellers. Hardware diagnostic support and repair is available for three years from date of purchase. Support for software and initial setup is available for 90 days from date of purchase. Enhancements to warranty services are available through HPE Services operational services or customized service agreements. Hard drives have either a one year or three year warranty; refer to the specific hard drive QuickSpecs for details.

Notes: Server Warranty includes 3-Year Parts, 3-Year Labor, 3-Year Onsite support with next business day response. Warranty repairs may be accomplished through the use of Customer Self Repair (CSR) parts. These parts fall into two categories: 1) Mandatory CSR parts are designed for easy replacement. A travel and labor charge will result when customers decline to replace a Mandatory CSR part; 2) Optional CSR parts are also designed for easy replacement but may involve added complexity. Customers may choose to have Hewlett Packard Enterprise replace Optional CSR parts at no charge. Additional information regarding worldwide limited warranty and technical support is available at: <https://www.hpe.com/support/ProLiantServers-Warranties>

Optional Features

Server Management

HPE iLO Advanced

HPE iLO Advanced licenses offer smart remote functionality without compromise, for all HPE ProLiant servers. The license includes the full integrated remote console, virtual keyboard, video, and mouse (KVM), multi-user collaboration, console record and replay, and GUI-based and scripted virtual media and virtual folders. You can also activate the enhanced security and power management functionality.

HPE OneView Advanced

HPE OneView Advanced offers a sophisticated level of automation to infrastructure management by taking a template-driven approach to provisioning, updating, and integrating compute, storage, and networking infrastructure. It builds upon the base features of HPE OneView Standard, provides full-featured licenses which can be purchased for managing multiple HPE server generations. To learn more visit <http://www.hpe.com/info/oneview>.

Rack and Power Infrastructure

The story may end with servers, but it starts with the foundation that makes compute go - and business grow. We've reinvented our entire portfolio of rack and power products to make IT infrastructure more secure, more practical, and more efficient. In other words, we have created a stronger, smarter, and simpler infrastructure to help you get the most out of your IT equipment. As an industry leader, Hewlett Packard Enterprise is uniquely positioned to address the key concerns of power, cooling, cable management and system access.

HPE G2 Advanced and Enterprise Racks are perfect for the server room or today's modern data center with enhanced airflow and thermal management, flexible cable management, and a 10-year Warranty to support higher density computing.

HPE G2 PDUs offer reliable power in flexible form factors that operate at temperatures up to 60°C, include color-coded outlets and load segments and a low-profile design for optimal access to the rack and support for dense rack environments.

HPE Uninterruptible Power Systems are cost-effective power protection for any type of workload. Some UPSs include options for remote management and extended runtime modules, so your critical dense data center is covered in power outages.

HPE KVM Solutions include a console and switches designed to work with your server and IT equipment reliably. We've got a cost-effective KVM switch for your first rack and multiple-connection IP switches with remote management and security capabilities to keep your data center rack up and running.

Learn more about HPE Racks, KVM, PDUs and UPSs at [HPE Rack and Power Infrastructure](#).

One Config Simple (OCS/SCE)

OCS/SCE is a guided self-service tool to help sales and non-technical people provide customers with initial configurations in 3 to 5 minutes. You may then send the configuration on for configuration help or use in your existing ordering processes. If you require "custom" rack configuration or configuration for products not available in SCE, please contact Hewlett Packard Enterprise Customer Business Center or an Authorized Partner for assistance.

<https://h22174.www2.hpe.com/SimplifiedConfig/Welcome>

Service and Support

HPE Services

No matter where you are in your digital transformation journey, you can count on HPE Services to deliver the expertise you need when, where, and how you need it. From planning to deployment, ongoing operations and beyond, our experts can help you realize your digital ambitions.

<https://www.hpe.com/services>

Consulting Services

No matter where you are on your journey to hybrid cloud, experts can help you map out your next steps. From determining what workloads should live where, to handling governance and compliance, to managing costs, our experts can help you optimize your operations.

<https://www.hpe.com/services/consulting>

HPE Managed Services

HPE runs your IT operations, providing services that monitor, operate, and optimize your infrastructure and applications, delivered consistently and globally to give you unified control and let you focus on innovation.

[HPE Managed Services | HPE](#)

Operational services

Optimize your entire IT environment and drive innovation. Manage day-to-day IT operational tasks while freeing up valuable time and resources. Meet service-level targets and business objectives with features designed to drive better business outcomes.

<https://www.hpe.com/services/operational>

HPE Complete Care Service

HPE Complete Care Service is a modular, IT environment service designed to help optimize your entire IT environment and achieve agreed upon IT outcomes and business goals through a personalized experience. All delivered by an assigned team of HPE Services experts. HPE Complete Care Service provides:

- A complete coverage approach
- An assigned HPE team.
- Modular and fully personalized engagement.
- Enhanced Incident Management experience with priority access.
- Digitally enabled and AI-driven customer experience.

<https://www.hpe.com/services/complecare>

HPE Tech Care Service

HPE Tech Care Service is the operational support service experience for HPE products. The service goes beyond traditional support by providing access to product specific experts, an AI-driven digital experience, and general technical guidance to not only reduce risk but constantly search for ways to do things better. HPE Tech Care Service delivers a customer-centric, AI-driven, and digitally enabled customer experience to move your business forward. HPE Tech Care Service is available on three response levels. Basic, which provides 9x5 business hour availability and a 2-hour response time. Essential, which provides a 15-minute response time 24x7 for most enterprise level customers, and Critical, which includes a 6-hour repair commitment where available and outage management response for severity 1 incidents.

<https://www.hpe.com/services/techcare>

Service and Support

HPE Lifecycle Services

HPE Lifecycle Services provide a variety of options to help maintain your HPE systems and solutions at all stages of the product lifecycle. A few popular examples include:

- Lifecycle Install and Startup Services: Various levels for physical installation and power on, remote access setup, installation and startup, and enhanced installation services with the operating system.
- HPE Firmware Update Analysis Service: Recommendations for firmware revision levels for selected HPE products, considering the relevant revision dependencies within your IT environment.
- HPE Firmware Update Implementation Service: Implementation of firmware updates for selected HPE server, storage, and solution products, considering the relevant revision dependencies within your IT environment.
- Implementation assistance services: Highly trained technical service specialists to assist you with a variety of activities, ranging from design, implementation, and platform deployment to consolidation, migration, project management, and onsite technical forums.
- HPE Service Credits: Access to prepaid services for flexibility to choose from a variety of specialized service activities, including assessments, performance maintenance reviews, firmware management, professional services, and operational best practices.

Notes: To review the list of Lifecycle Services available for your product, go to:

<https://www.hpe.com/services/lifecycle>

For a list of the most frequently purchased services using service credits, see the [HPE Service Credits Menu](#)

Other Related Services from HPE Services

HPE Education Services

Training and certification designed for IT and business professionals across all industries. Broad catalogue of course offerings to expand skills and proficiencies in topics ranging from cloud and cybersecurity to AI and DevOps. Create learning paths to expand proficiency in a specific subject. Schedule training in a way that works best for your business with flexible continuous learning options.

<https://www.hpe.com/services/training>

Defective Media Retention

An option available with HPE Complete Care Service and HPE Tech Care Service and applies only to Disk or eligible SSD/Flash Drives replaced by HPE due to malfunction.

Consult your HPE Sales Representative or Authorized Channel Partner of choice for any additional questions and service options.

Parts and Materials

HPE will provide HPE-supported replacement parts and materials necessary to maintain the covered hardware product in operating condition, including parts and materials for available and recommended engineering improvements.

Parts and components that have reached their maximum supported lifetime and/or the maximum usage limitations as set forth in the manufacturer's operating manual, product QuickSpecs, or the technical product data sheet will not be provided, repaired, or replaced as part of these services.

How to Purchase Services

Services are sold by Hewlett Packard Enterprise and Hewlett Packard Enterprise Authorized Service Partners:

- Services for customers purchasing from HPE or an enterprise reseller are quoted using HPE order configuration tools.
- Customers purchasing from a commercial reseller can find services at <https://ssc.hpe.com/portal/site/ssc/>

AI Powered and Digitally Enabled Support Experience

Achieve faster time to resolution with access to product-specific resources and expertise through digital and data driven customer experience

Sign into the HPE Support Center experience, featuring streamlined self-serve case creation and management capabilities with inline knowledge recommendations. You will also find personalized task alerts and powerful troubleshooting support through an intelligent virtual agent with seamless transition when needed to a live support agent.

<https://support.hpe.com/hpsc/public/home/signin>

GreenLake

[GreenLake](#) is the cloud to run and manage your entire hybrid landscape-private, public, and edge. It helps you to:

- Streamline IT Operations across compute, storage, and networking without the chaos
 - Unify and secure data, as you move faster
-

Service and Support

– Accelerate AI, from pilot to production

The result: greater operational efficiency, lower TCO, and faster AI delivery—all from one unified, intelligent platform built for today's hybrid enterprise.

Pre-configured Models

HPE Smart Choice Purchase Program

The HPE Smart Choice Purchase Program features popular fully configured products that can be quoted in minutes and shipped quickly through HPE Authorized Partners. Products are configured and tested in an HPE factory and stocked at HPE Authorized Distributors and Partners. The products arrive in a single box, making onsite integration easier and more efficient for partners and customers. Additionally, there are aggressively priced HPE Tech Care Services available only through the HPE Smart Choice program when you purchase an HPE Smart Choice product.

For HPE Smart Choice configuration and product details, please visit the Smart Choice Supplemental QuickSpecs:

<https://www.hpe.com/psnow/doc/a50009219enw>

Base & Performance Model

SKU Number	P66779-291	P66780-291
Model Name	HPE ProLiant DL365 Gen11 9124 3.0GHz 16-core 1P 32GB-R 8SFF 800W PS Server	HPE ProLiant DL365 Gen11 9224 2.5GHz 24-core 1P 32GB-R 8SFF 800W PS Server
Processor	9124 (16-Core, 3.0 GHz, 240W)	9224 (24-Core, 2.5 GHz, 240W)
Number of Processors	One processor	One processor
Memory	32 GB RDIMM DR 4800 MT/s (1x 2Rx8 32 GB)	32 GB RDIMM DR 4800 MT/s (1x 2Rx8 32 GB)
Network Controller	BCM 5719 1GbE 4p BASE-T OCP3 Adapter plus choice of standup card	BCM 57416 10GbE 2p BASE-T OCP3 Adapter plus choice of standup card
Storage Controller	HPE MR408i-o Gen11 x8 Lanes 4GB Cache OCP SPDM Storage Controller	HPE MR408i-o Gen11 x8 Lanes 4GB Cache OCP SPDM Storage Controller
Hard Drive	None ship as standard	None ship as standard
Internal Storage	8 SFF Chassis (upgradeable to 10 SFF front)	8 SFF Chassis (upgradeable to 10 SFF front)
Optical Drive Bay	Optional	Optional
Optical Drive	None ship as standard	None ship as standard
PCI-Express Slots	1 slot (x16) as standard (2 nd Slot upgradeable. Please refer to PCIe slot section in this doc)	1 slot (x16) as standard (2 nd Slot upgradeable. Please refer to PCIe slot section in this doc)
Power Supply	1x 800W HPE FlexSlot Power Supply	1x 800W HPE FlexSlot Power Supply
Fans	5-standard fans	5-standard fans
Management	Default: HPE iLO Standard with Intelligent Provisioning, HPE OneView Standard (requires download)	Default: HPE iLO Standard with Intelligent Provisioning, HPE OneView Standard (requires download)
ENERGY STAR®	3.0 certified	3.0 certified
Form Factor	1U Rack	1U Rack
Warranty	3-year parts, 3-year labor, 3-year onsite support with next business day response.	3-year parts, 3-year labor, 3-year onsite support with next business day response.

Country Code Key

xx1 = B21 Worldwide

xx1 = 291 Japan

xx1 = AA1 PRC

xx1 = 421 EU

Configuration Information

Smart Templates from HPE

HPE is releasing new Smart Template technology in the One Config Advanced (OCA) configurator. These Templates represent the CTO equivalents of the top-selling BTO configurations. They are intended to provide simple starting points to assist you in easily creating and customizing your desired Server solutions. HPE Servers that have Platform Templates, developed by HPE Product Managers, will have a separate tab in the HPE OCA configurator.

Workload Solutions Templates from HPE

The Workload Solutions Templates are built on the Smart Templates technology to easily develop working configurations of the most compelling Workload Solutions. The templates complement the Reference Builds developed by HPE. Workload Solutions templates preconfigure some of the key architecture decisions and make it easier for Sellers to get started and complete a differentiated server solution for your customer's specific workload.

Mainstream SKUs

HPE launched the Mainstream SKU initiative as a market-driven approach to Demand Steering. It is a simplified portfolio of our top selling options that meet the current and future market trends. HPE has committed to providing a more predictable and faster experience for these options. Mainstream SKUs enjoy higher safety stock levels and have higher fulfillment service levels than non-Mainstream SKUs. Mainstream orders are fulfilled +30% faster than non-Mainstream orders, have fewer shortages and better recovery dates. This platform has Mainstream SKUs in the options portfolio, and is eligible for the improved Mainstream experience. Mainstream SKUs are designated with a Mainstream symbol in our configurators.

Mainstream Configurations

HPE is using the new Smart Templates technology to present Mainstream configurations. All the options in a Mainstream configuration are pre-selected Mainstream SKUs to optimize the performance, predictability and fulfillment experience. Check the Template section in our configurators for eligible Mainstream configurations.

European Union ErP Lot 9 Regulation

Beginning on January 1st, 2024, units sold into the European Union (EU), European Economic Area (EEA), the United Kingdom, Ireland, Switzerland or Turkey, must include more efficient AC power supplies: 94% for multi-output and 96% for single-output. HPE Flexible Slot power supplies are single-output, and part numbers 865438-B21, P03178-B21, and P44712-B21 are 96% efficient, thus meeting requirements.

HPE is on target to fulfill compliant systems ahead of time and will begin enforcing these requirements in advance to satisfy requests with the current power supplies by the set deadline.

This section lists some of the steps required to configure a Factory Integrated Model. To ensure only valid configurations are ordered, Hewlett Packard Enterprise recommends the use of an HPE approved configurator. Contact your local sales representative for information on configurable product offerings and requirements.

- Factory Integrated Models must start with a CTO Server.
- FIO indicates that this option is only available as a factory installable option.
- All Factory Integrated Models will be populated with sufficient hard drive blanks based on the number of initial hard drives ordered with the server
- Some options may not be integrated at the factory. Contact your local sales representative for additional information.

Step 1: Base Configuration (choose one of the following configurable models)

Configuration Information

CTO Server	HPE ProLiant DL365 Gen11 8SFF CTO Server
HPE ProLiant DL365 Gen11 8SFF Configure-to-order Server	P53933-B21
Processor	Not included as standard
DIMM Slots	24-DIMM slots*
Storage Controller	Choice of HPE OCP or PCIe plug-in controller
PCIe	1 PCIe x16 Primary Riser
Drive Cage - included	8 SFF (Backplane is not included)
Network Controller	Choice of OCP and stand-up card
Fans	Not included as standard**
Management	Default: HPE iLO Standard with Intelligent Provisioning, HPE OneView Standard (requires download), HPE Compute Ops Management (subscription included)
USB	Front : 1x USB 3.2 Gen 1 + 1x iLO service port Rear: 2x USB 3.2 Gen 1 Internal: 2x USB 3.2 Gen 1
CTO Server	HPE ProLiant DL365 Gen11 EDSFF CTO Server
HPE ProLiant DL365 Gen11 EDSFF Configure-to-order Server	P53934-B21
Processor	Not included as standard
DIMM Slots	24-DIMM slots*
Storage Controller	Choice of HPE OCP or PCIe plug-in controller
PCIe	1 PCIe x16 Primary Riser
Drive Cage - included	20 EDSFF
Network Controller	Choice of OCP and stand-up card
Fans	Not included as standard**
Management	Default: HPE iLO Standard with Intelligent Provisioning, HPE OneView Standard (requires download), HPE Compute Ops Management (subscription included)
USB	Front : 1x USB 3.2 Gen 1 + 1x iLO service port Rear: 2x USB 3.2 Gen 1 Internal: 2x USB 3.2 Gen 1
CTO Server	HPE ProLiant DL365 Gen11 GPU CTO Server
HPE ProLiant DL365 Gen11 GPU Configure-to-order Server	P53935-B21
Processor	Not included as standard
DIMM Slots	24-DIMM slots*
Storage Controller	Choice of HPE OCP or PCIe plug-in controller
PCIe	1 PCIe x16 Primary Riser and 1 GPU Riser (GPU Riser located in front chassis)
Drive Cage - included	20 EDSFF
Network Controller	Choice of OCP and stand-up card
Fans	Not included as standard**
Management	Default: HPE iLO Standard with Intelligent Provisioning, HPE OneView Standard (requires download), HPE Compute Ops Management (subscription included)
USB	Front : 1x USB 3.2 Gen 1 + 1x iLO service port Rear: 2x USB 3.2 Gen 1 Internal: 2x USB 3.2 Gen 1

Notes:

- *24 DIMM slots require selection of two processors.
- ** Fans should be selected separately depending on the configuration.
- HPE offers multiple Trade Agreement Act (TAA) compliant configurations to meet the needs of US Federal Government customers. These products are either manufactured or substantially transformed into a designated country. TAA compliance is only provided when HPE options are included as part of factory integrated orders (CTO).
- If EDSFF CTO model is selected, then two processors must be selected.
- If EDSFF CTO model is selected, then "Performance Heatsink or DLC" and "Performance Fan" must be selected.
- TAA compliant configuration requires TAA versions of the CTO Server SKUs.
- All CTO servers are ENERGY STAR® 3.0 compliant.

Configuration Information

CTO Server	8 SFF CTO Chassis
Included Drive Cage	8 SFF (backplane not included)
Universal Media Bay	Optional
ODD	Optional
8 SFF SAS/SATA/NVMe	Up to 1 Optional
2 SFF SAS/SATA/NVMe	Up to 1 Optional
Rear Drive Cages	Not Available

Notes: This applies to CTO configurations; field upgrades may differ depending on field configuration.

Backplane Types - Compatible Drive Type

	SATA	SAS	NVMe (U.3 Static)	NVME (U.3 Dynamic)
8 SFF U.3 Tri-mode BP	x	x	x	x
2 SFF U.3 Tri-mode BP	x	x	x	x

Notes: U.2 backplanes are supported only as private options. U.2 backplanes do not support static drives, only the dynamic U.3 drives. U.2 backplanes also do not support SAS/SATA drives.

Step 2: Choose Required Options (only one of the following unless otherwise noted)

Please select one -B21 processor required below.

For second processor, please select the same processor model with -B21 from Core Options - HPE Processors section.

Notes:

- 4th generation AMD EPYC™ 9004 series processors are compatible with 4800 MT/s memory DIMMs, 5th generation AMD EPYC™ 9005 series processors are compatible with 6400 MT/s
- 5th generation AMD EPYC™ 9005 processors are compatible with NS204i-u V2
- For processors less than or equal to 240W, standard heatsink, and standard fan kit are required. Users are allowed to change to performance heatsink and performance fan kit.
- For processors more than 240W, performance heatsink, and performance fan kit are required. Users are allowed to remove performance heatsink and select DLC module.
- For processors more than or equal to 320W, maximum eight quantity of 8SFF drives can be selected, and maximum 12 quantity of EDSFF drives can be selected.
- Mixing of two different processor models is NOT allowed. For example: first processor, select P53696-B21 then for second processor, select P53696-B21 as well.
- Processor kits don't include heat sink and fans.

Step 2a: Choose Processors

Processor Option Kits

AMD EPYC™ 5th Generation 9005 Series

AMD EPYC 9845 2.1GHz 160-core 390W Processor for HPE	P72646-B21
AMD EPYC 9825 2.2GHz 144-core 390W Processor for HPE	P72647-B21
AMD EPYC 9745 2.4GHz 128-core 400W Processor for HPE	P72648-B21
AMD EPYC 9655 2.6GHz 96-core 400W Processor for HPE	P72650-B21
AMD EPYC 9645 2.3GHz 96-core 320W Processor for HPE	P72649-B21
AMD EPYC 9565 3.15GHz 72-core 400W Processor for HPE	P72651-B21
AMD EPYC 9575F 3.3GHz 64-core 400W Processor for HPE	P72758-B21
AMD EPYC 9555 3.2GHz 64-core 360W Processor for HPE	P72653-B21
AMD EPYC 9535 2.4GHz 64-core 300W Processor for HPE	P72652-B21
AMD EPYC 9475F 3.65GHz 48-core 400W Processor for HPE	P72666-B21
AMD EPYC 9455 3.15GHz 48-core 300W Processor for HPE	P72654-B21
AMD EPYC 9365 3.4GHz 36-core 300W Processor for HPE	P72655-B21
AMD EPYC 9375F 3.80GHz 32-core 320W Processor for HPE	P72667-B21
AMD EPYC 9355 3.55GHz 32-core 280W Processor for HPE	P72657-B21
AMD EPYC 9335 3.0GHz 32-core 210W Processor for HPE	P72656-B21
AMD EPYC 9275F 4.1GHz 24-core 320W Processor for HPE	P72668-B21
AMD EPYC 9255 3.20GHz 24-core 200W Processor for HPE	P72658-B21
AMD EPYC 9175F 4.2GHz 16-core 320W Processor for HPE	P72669-B21
AMD EPYC 9135 3.65GHz 16-core 200W Processor for HPE	P72660-B21

Configuration Information

AMD EPYC 9115 2.6GHz 16-core 125W Processor for HPE	P72659-B21
AMD EPYC 9015 3.6GHz 8-core 125W Processor for HPE	P72661-B21
AMD EPYC™ 4 th Generation 9004 Series	
AMD EPYC 9754 2.25GHz 128-core 360W Processor for HPE	P60463-B21
AMD EPYC 9684X 2.55GHz 96-core 400W Processor for HPE	P63493-B21
AMD EPYC 9654 2.4GHz 96-core 360W Processor for HPE	P53696-B21
AMD EPYC 9634 2.25GHz 84-core 290W Processor for HPE	P53705-B21
AMD EPYC 9554 3.1GHz 64-core 360W Processor for HPE	P53700-B21
AMD EPYC 9534 2.45GHz 64-core 280W Processor for HPE	P53699-B21
AMD EPYC 9474F 3.6GHz 48-core 360W Processor for HPE	P53706-B21
AMD EPYC 9454 2.75GHz 48-core 290W Processor for HPE	P53708-B21
AMD EPYC 9384X 3.1GHz 32-core 320W Processor for HPE	P63492-B21
AMD EPYC 9374F 3.85GHz 32-core 320W Processor for HPE	P53710-B21
AMD EPYC 9354 3.25GHz 32-core 280W Processor for HPE	P53701-B21
AMD EPYC 9334 2.7GHz 32-core 210W Processor for HPE	P53712-B21
AMD EPYC 9274F 4.05GHz 24-core 320W Processor for HPE	P53711-B21
AMD EPYC 9254 2.9GHz 24-core 200W Processor for HPE	P53707-B21
AMD EPYC 9224 2.5GHz 24-core 200W Processor for HPE	P58540-B21
AMD EPYC 9184X 3.55GHz 16-core 320W Processor for HPE	P63491-B21
AMD EPYC 9174F 4.1GHz 16-core 320W Processor for HPE	P53698-B21
AMD EPYC 9124 3.0GHz 16-core 200W Processor for HPE	P53702-B21

Step 2b: Choose Memory Options

Please select one or more memory from below.

For new Gen11 memory population rule whitepaper and optimal memory performance guidelines, please go to

For additional information, refer to the [HPE DDR5 Smart Memory QuickSpecs](#).

Notes:

- Memory DIMM availability with a server platform is dependent upon completion of certification testing.
- The maximum memory speed is a function of the memory type, memory configuration, and processor model.
- Memory compatibility may vary or be limited within a specific server family depending upon the specific configuration being requested. Because each server environment and requirements can vary, memory compatibility is based not only upon the server family but may also be affected by the amount and type of additional hardware options installed within a specific server configuration. For this reason, some HPE memory DIMMs may be qualified as a server model or family and yet occasionally not be supported with limited configurations within that server family. Please consult with the HPE server QuickSpecs or your HPE representative if you have any questions regarding memory compatibility with a specific HPE server configuration.
- The -B21 memory SKUs shown in this document are to be used when ordering stand-alone memory only. For each -B21 SKU, there is a corresponding -F21 SKU which is to be used when configuring servers with integrated memory DIMMs

Registered DIMMs (RDIMMs)

4800 MT/s DDR5 DIMMs compatible with AMD EPYC™ 4th Generation CPUs

HPE 16GB (1x16GB) Single Rank x8 DDR5-4800 CAS-40-39-39 EC8 Registered Smart Memory Kit	P50309-B21
HPE 32GB (1x32GB) Dual Rank x8 DDR5-4800 CAS-40-39-39 EC8 Registered Smart Memory Kit	P50311-B21
HPE 64GB (1x64GB) Dual Rank x4 DDR5-4800 CAS-40-39-39 EC8 Registered Smart Memory Kit	P50312-B21
HPE 96GB (1x96GB) Dual Rank x4 DDR5-4800 CAS-46-45-45 EC8 Registered Smart Memory Kit	P66676-B21
HPE 128GB (1x128GB) Dual Rank x4 DDR5-4800 CAS-40-39-39 EC8 Registered Smart Memory Kit	P69982-B21
HPE 256GB (1x256GB) Quad Rank x4 DDR5-4800 CAS-60-52-52 EC8 Registered 3DS Smart Memory Kit	P90552-B21

6400 MT/s DDR5 DIMMs compatible with AMD EPYC™ 5th Generation CPUs

HPE 16GB (1x16GB) Single Rank x8 DDR5-6400 CAS-52-52-52 EC8 Registered Smart Memory Kit	P64984-B21
HPE 32GB (1x32GB) Dual Rank x8 DDR5-6400 CAS-52-52-52 EC8 Registered Smart Memory Kit	P64985-B21
HPE 64GB (1x64GB) Dual Rank x4 DDR5-6400 CAS-52-52-52 EC8 Registered Smart Memory Kit	P64986-B21
HPE 96GB (1x96GB) Dual Rank x4 DDR5-6400 CAS-52-52-52 EC8 Registered Smart Memory Kit	P64987-B21
HPE 128GB (1x128GB) Dual Rank x4 DDR5-6400 CAS-52-52-52 EC8 Registered Smart Memory Kit	P64988-B21
HPE 256GB (1x256GB) Quad Rank x4 DDR5-6400 CAS-60-52-52 EC8 Registered 3DS Smart Memory Kit	P73446-B21

Notes:

- HPE Gen11 DDR5 6400 MT/s Smart Memory is compatible with AMD EPYC™ 5th Generation CPUs.
- Mixing of x4 & x8 memory is not allowed.
- Mixing of Non-3DS and 3DS DIMMs is not allowed.

Configuration Information

- 96GB/128GB/128GB 2Rx4 memory cannot be mixed with any other memory.
- The 128GB 2Rx4 RDIMM (P69982-B21) for 4th Gen AMD EPYC™ and 128GB 2Rx4 RDIMM (P64988-B21) for 5th Gen AMD EPYC™ are not 3DS DIMMs.
- If 128GB/256GB Memory is selected, then Performance Heatsink, and 7 Performance Fan must be selected.
- 256GB DIMM imposes more configuration restrictions due to its high-profile thermal condition. Refer to the HPE configurator tool for detailed instructions.
- For more detailed information regarding memory population rules, please visit <https://www.hpe.com/docs/server-memory>

Memory Blank Kit

HPE DDR4 DIMM Blank Kit

P07818-B21

Notes: DIMM blank kit cannot be selected when 24 DIMMs are ordered.

Thermal Support Matrix - Processors

Front End	Drive Configuration	Support Ambient	CPU TDP (cTDP)	FAN Type	Heatsink Type
SFF	SFF x8 SATA/SAS	35°C	240 W	Standard	Standard
SFF	SFF x10 SATA/SAS SFF NVMe	35°C	240 W	Performance	Standard
SFF	SFF x10 NVMe/SAS4/SAS/SATA	35°C	300 W	Performance	Performance
SFF	SFF x8 NVMe/SAS4/SAS/SATA	25°C	400 W	Performance	Performance
SFF	SFF x10 NVMe/SAS4/SAS/SATA	35°C	400 W	Performance	Direct Liquid Cooling
EDSFF	EDSFF 20 x 25 W	35°C	240 W	Performance	Performance
EDSFF		35°C	300 W	Performance	Performance
EDSFF	EDSFF 12 x 25 W	25°C	400 W	Performance	Performance
EDSFF	EDSFF 20 x 25 W	35°C	400 W	Performance	Direct Liquid Cooling
GPU	EDSFF 8 x 25 W	35°C	240 W	Performance	Performance
GPU	SFF 4 x 25 W	25°C	300 W	Performance	Performance
GPU		35°C	400 W	Performance	Direct Liquid Cooling

Notes: Scopes listed above are general support guidance. Support conditions may vary depending on other options selected.

DIMM Support Matrix for Ambient Temperature

256 GB Support Max Quantity

Front End	256 GB Support Max Quantity*	Support Ambient Temperature
SFF	24	25 °C
EDSFF	16	25 °C
GPU	20	25 °C
SFF/EDSFF/GPU with Direct Liquid Cooling	24/20/20	25 °C

16 GB, 32 GB, 64 GB, 128 GB Support Max Quantity

Front End	16 GB, 32 GB, 64 GB, 128 GB Support Max Quantity	Support Ambient Temperature
SFF	24	35 °C
EDSFF	24	35 °C
GPU	24	35 °C
SFF/EDSFF/GPU with Direct Liquid Cooling	24/24/24	35 °C

Configuration Information

Step 2c: Choose Power Supplies

Select one or two power supplies from below.

Notes: Mixing of 2 different power supplies is NOT allowed.

HPE Flex Slot Power Supplies

HPE 1800W-2200W Flex Slot Titanium Hot Plug Power Supply Kit	P44712-B21
HPE 1600W Flex Slot Platinum Hot Plug Low Halogen Power Supply Kit	P38997-B21
HPE 1600W Flex Slot -48VDC Hot Plug Power Supply Kit	P17023-B21
HPE 1000W Flex Slot Titanium Hot Plug Power Supply Kit	P03178-B21
HPE 800W Flex Slot Platinum Hot Plug Low Halogen Power Supply Kit	P38995-B21

Notes:

- Mixing of different Power Supply SKU is not allowed.
- 1600W -48VDC PSU requires 1x HPE 1600W DC PSU power lug option kit or HPE 1600W DC PSU Power Cable Kit.
- 1800W-2200W PSU only supports high line voltage (200VAC to 240VAC).
- Prior to making a power supply selection it is highly recommended that the HPE Power Advisor is run to determine the right size power supply for your server configuration. The HPE Power Advisor is located at: <http://www.hpe.com/info/poweradvisor>
- HPE ProLiant servers ship with an IEC-IEC power cord used for rack mounting with Power Distribution Units (PDUs). Visit [HPE power cords](#) for a full list of optional power cords.

Step 2d: Choose Backplane

If front drives are needed in the server, please select one backplane from list below

HPE ProLiant DL365 Gen11 8SFF Tri-Mode U.3 x1 BC FIO Backplane Kit	P55020-B21
--	------------

Notes:

- x1 U.3 8SFF Drive cage can only support SAS/SATA/NVMe drives.
- Configurable up to 1.
- OROC and PCIe controllers support this backplane. OROC x1 or PCIe x1 cable kit selection is needed for controller support.
- Mixture of x1 U.3 8SFF and x4 U.3 8SFF backplanes is ALLOWED.

HPE ProLiant DL365 Gen11 8SFF Tri-Mode U.3 x4 BC FIO Backplane Kit	P55021-B21
--	------------

Notes:

- x4 U.3 8SFF Drive cage can support SAS/SATA/NVMe drives.
- Configurable up to one.
- OROC and PCIe controllers support this backplane. OROC x1/x2/x4 or PCIe x1/x4 cable kit is supportable for controller support.
- Mixing of NVMe and SAS/ SATA is NOT allowed in the same drive cage if any Tri-mode controller is not selected for drive cage.

HPE ProLiant DL365 Gen11 2SFF Tri-Mode U.3 x4 BC Balanced Backplane Kit	P55025-B21
---	------------

Notes:

- x4 U.3 2SFF Drive cage can support SAS/SATA/NVMe drives.
- Configurable up to one.
- OROC and PCIe controllers support this backplane. OROC x1/x2/x4 or PCIe x1/x4 cable kit is supportable for controller support.

HPE ProLiant DL365 Gen11 4SFF Tri-Mode U.3 x4 BC FIO Backplane Kit	P63212-B21
--	------------

Notes:

- Supported with GPU CTO model only.
- Min/Max = 1 of this drive cage must be selected for GPU CTO model.
- Supports NVMe drives only. SAS/SATA drives are not supported.
- If this drive cage is selected, then internal controllers cannot be selected. Will be direct attached to motherboard.

HPE ProLiant DL365 Gen11 8EDSFF NVMe FIO Backplane Kit	P63215-B21
--	------------

Notes:

- Supported with GPU CTO model only.
- Min/Max = 1 of this drive cage must be selected for GPU CTO model.
- If this drive cage is selected, then internal controllers cannot be selected. Will be direct attached to motherboard.

Configuration Information

HPE ProLiant DL365 Gen11 GPU 4SFF x2 OCP Tri-Mode Bundle Kit

P71757-B21

Notes:

- Supported with GPU CTO model only.
 - If P71757-B21 is selected, then MR408i-o controller must be selected. Other controllers are not allowed.
 - Mixing of NVMe and SAS/SATA is NOT allowed in the same drive cage if any of the Tri-Mode controller is not selected for drive cage.
-

Step 3: Choose Additional Factory Integratable Options

One of the following from each list may be selected if desired at time of factory integration

System Insight Display Options

HPE ProLiant DL365 Gen11 SFF System Insight Display Module Kit

P56924-B21

Notes: Only a quantity of one can be supported.

Core Options

Step 4: Choose additional options for Factory Integration from Core and Additional Options sections below

Some options may not be integrated at the factory. To ensure only valid configurations are ordered, Hewlett Packard Enterprise recommends the use of a Hewlett Packard Enterprise approved configurator. Contact your local sales representative for additional information.

Software as a Service Management

HPE Compute Ops Management

Base SKU

HPE Compute Ops Management Standard 3-year Upfront ProLiant SaaS R7A11AAE

Upgrade SKUS

HPE Compute Ops Management Advanced 1-year Upfront ProLiant SaaS S5E58AAE

HPE Compute Ops Management Advanced 3-year Upfront ProLiant SaaS S5E59AAE

HPE Compute Ops Management Advanced 5-year Upfront ProLiant SaaS S5E60AAE

HPE Compute Ops Management Advanced 7-year Upfront ProLiant SaaS S5E61AAE

HPE Compute Ops Management Standard 5-year Upfront ProLiant SaaS R7A12AAE

HPE Compute Ops Management Standard 7-year Upfront ProLiant SaaS S2E10AAE

HPE Compute Ops Management Base SaaS R6Z73AAE

HPE Compute Cloud Management Server FIO Enablement S1A05A

HPE Compute Ops Management Advanced Flex with ProLiant Enablement S6C28AAE

Notes: For customers purchasing HPE Compute Ops Management, without a hardware purchase or a BTO purchase, use this base SKU within ASQ order:

For more information, visit the HPE Compute Ops Management QuickSpecs:

<https://www.hpe.com/psnow/doc/a50004263enw>

Supported Servers - CTO only. No OEM. - Complete list can be found here: Latest Supported Server List:

<https://www.hpe.com/info/com-supported-servers>

HPE Unique Options

Riser Kits

The CTO or BTO server has 1x Primary riser by default. Here are the additional risers available to select

HPE ProLiant DL3X5 Gen11 1U x16 Low Profile Secondary Riser Kit P55029-B21

HPE ProLiant DL3X5 Gen11 1U x16 Riser Kit P56915-B21

Notes:

– Both riser kits are in the secondary slot.

– Low Profile Secondary riser kit (P55029-B21) must be selected when HPE NS204i-u Gen11 NVMe boot device (P48183-B21) in the order.

Core Options

Riser Support Matrix							
Primary Riser Part Number	Secondary Riser Part Number	Description	Riser position (number denotes number of slots present)		Bus width (Gen5 lanes)		Remark
			Primary	Secondary	Primary	Secondary	
Default riser		This is the default riser in the chassis.	1	0	X16	0	This scenario is valid for 8SFF CTO Server
Default riser	Default riser	These are the default risers in the chassis.	1	1	X16	X16	This scenario is valid for EDSFF & GPU CTO Servers
Default riser	P56915-B21	Default riser + HPE ProLiant DL3X5 Gen11 1U x16 Riser Kit	1	1	X16	X16	
Default riser	P55029-B21	Default riser + HPE ProLiant DL3X5 Gen11 1U x16 Low Profile Secondary Riser Kit	1	1	X16	X16	This scenario is when HPE NS204i-u Gen11 NVMe boot device (P48183-B21) is configured. In this case, the secondary slot will be a Low Profile PCIe slot

Cooling Options

Direct Liquid Cooling (DLC) is available on the HPE ProLiant DL365 Gen11 server. Direct Liquid Cooling is a fully rack-contained and integrated water-cooled system that enhances power usage effectiveness (PUE) and reduces cooling costs, resulting in lower operating costs. The HPE direct liquid cooling distribution unit manages server heat by directing coolant through cold plates that sit directly on the hottest components inside the server (namely, the CPUs). Coolant flows through these cold plates, captures heat, and then pumps it elsewhere to be cooled. This very energy-efficient approach cools the most powerful CPUs on the market today, without the typical thermal issues created by air cooling.

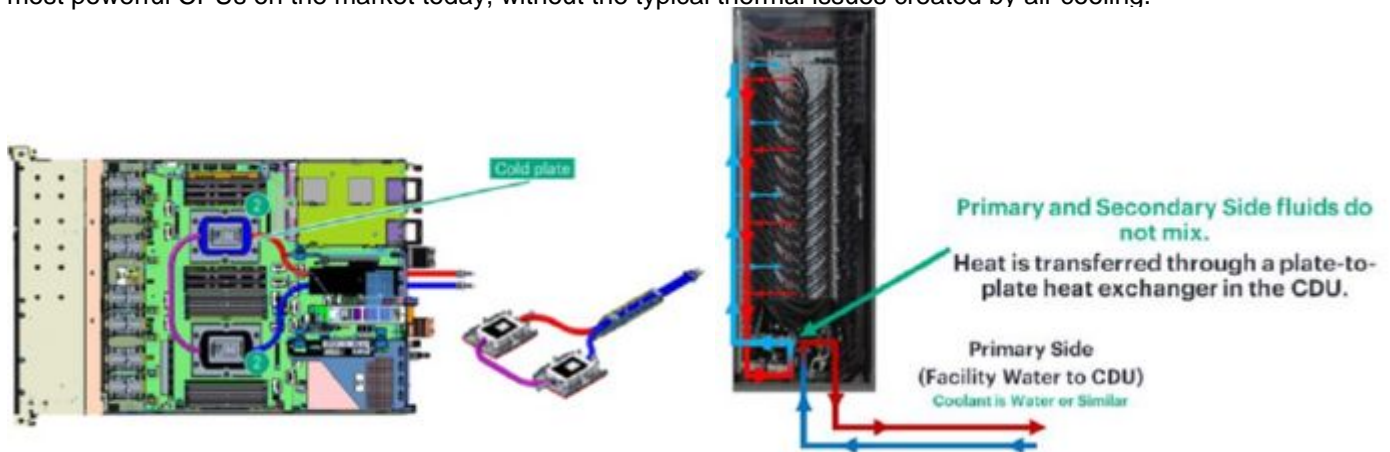

Core Options

HPE ProLiant DL3X5 Gen11 1U CPU Standard Heat Sink Kit	P58456-B21
HPE ProLiant DL3X5 Gen11 1U CPU Performance Heat Sink Kit	P58457-B21
HPE ProLiant DL3X5 Gen11 Direct Liquid Cooling Cold Plate Module FIO Kit From Boot Device	P62032-B21
HPE ProLiant DL3X5 Gen11 Direct Liquid Cooling Cold Plate Module FIO Kit From PCIe	P62035-B21
HPE ProLiant DL3XX Gen11 Direct Liquid Cooling 55cm Quick Disconnect Tube Set FIO Kit	P62042-B21
HPE ProLiant Direct Liquid Cooling 450mm Female-Male Connection Quick Disconnect Tube Set FIO Kit	P62046-B21

Notes:

- Mixing of both Standard and Performance Heatsink is not allowed.
- If any of "U.3 x4 drive cage" is selected, "Performance Heatsink or DLC Module" and 7 Performance Fans must be selected.
- For processors less than 240W with 8x SAS/SATA drives configured, standard heat sink (P58456-B21) and standard fan kit (P58461-B21) are required.
- For processors less than 240W with 10x SAS/SATA or NVMe drives configured, standard heat sink (P58456-B21) and performance fan kit (P58462-B21) are required.
- For processors above 240W, performance heat sink kit (P58457-B21) and performance fan kit (P58462-B21), or DLC module and performance fan kit are required.
- If "PCIe DLC Module" is selected, then Maximum limit for PCIe card limit will be reduced from 2 to 1 per server. (DLC PCIe Module occupies Slot# 2).
- If DLC Module is selected, then quantity 2 of Processor and 1 of Secondary LP module must be selected.
- For EDSFF CTO model, if selected processor wattage is greater than or equal to 320W, then DLC module must be selected.
- Max of 1 tube set can be selected.
- If DLC Module is selected, then tube set must be selected and vice versa.
- 55cm Quick Disconnect Tube Set supported with 8SFF/EDSFF CTO model only.
- 450mm(45cm) Quick Disconnect Tube Set supported with GPU CTO model only.

HPE ProLiant DL3XX Gen11 1U Standard Fan Kit	P58461-B21
HPE ProLiant DL3XX Gen11 1U Performance Fan Kit	P58462-B21

Notes:

- Gen11 Fan Kits contain only 1 fan.
- 1-socket config 5 Standard Fan kits, 2-socket config needs 7 Standard Fan kits.
- 1-socket config 5 Performance Fan kits, 2-socket config needs 7 Performance Fan kits.

Cooling options summary			
CPU cTDP	=< 240W (8x SAS/SATA drives)	=< 240W (10x SAS/SATA or =>1 NVMe drives)	>240W
Heatsink	Standard 1U H/S	Standard 1U H/S	Performance 1U H/S
Fans	Standard Fans	Performance Fans	Performance Fans

Core Options

HPE Boot Controllers

HPE NS204i-u Gen11 NVMe Hot Plug Boot Optimized Storage Device	P48183-B21
HPE NS204i-u v2 480GB NVMe Hot Plug Boot Optimized Storage Device	P78279-B21
HPE NS204i-u v2 960GB NVMe Hot Plug Boot Optimized Storage Device	P81160-B21
HPE NS204i-u v2 960GB NVMe SED Hot Plug Boot Optimized Storage Device	P81162-B21
HPE ProLiant DL3X5 Gen11 NS204i-u NVMe Hot Plug Boot Device Cable Kit	P57013-B21

- Notes:
- NS204i-u is the HPE Gen11 Hot-pluggable M.2 NVMe RAIDed Boot Device.
 - HPE DL3X5 Gen11 NS204i-u NVMe Boot Cable Kit is required when the NS204i-u boot device is configured along with the 4LFF rear cage.
 - If NS204i-u is selected, then 7 quantities of fan must be selected.
 - If NS204i-u is selected and secondary riser is required, HPE DL3X5 Gen11 1U x16 LP Sec Riser Kit must be selected.
 - If AMD EPYC™ 5th Generation CPUs are selected, then NS204i-u V2 P78279-B21 must be selected.

HPE Optical Drives and Option Kit

HPE 9.5mm SATA DVD-ROM Optical Drive	726536-B21
HPE 9.5mm SATA DVD-RW Optical Drive	726537-B21
HPE Mobile USB DVD-RW Optical Drive	701498-B21
HPE ProLiant DL365 Gen11 2SFF Display Port ODD Blank Kit	P56899-B21

- Notes:
- Maximum 1 Optical Drive is supported.
 - ODD needs selection of a HPE DL365 Gen11 2SFF DP ODD Blank Kit.

HPE RAID Controllers

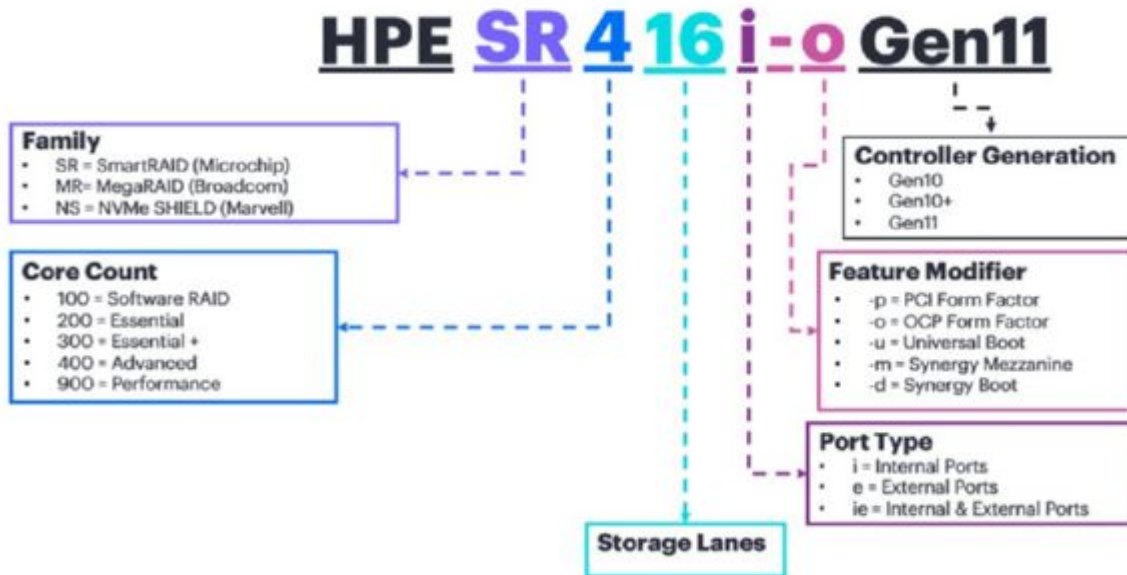

- Notes:
- When selecting SR RAID controllers for external storage (E208e, 804398-B21) and MR RAID controllers for internal storage (MR216i/MR416i/MR408i) in the order, please be aware these two products use different RAID configuration tools.
 - Not supporting mixing of MR (MegaRAID) series internal controllers and SR (SmartRAID) series internal controllers.
 - MR (MegaRAID) series controllers are not supported with Intelligent Provisioning feature.
 - For more information on the HPE Gen11 Storage Controller, please refer to:

[HPE Compute MR Gen11 Controllers QuickSpecs](#)

[HPE Compute SR Gen11 Controllers QuickSpecs](#)

Essential RAID Controllers

HPE Smart Array E208e-p SR Gen10 (8 External Lanes/No Cache) 12G SAS PCIe Plug-in Controller	804398-B21
--	------------

Core Options

Notes:

- This controller supports up to 8 SAS/SATA Drives (external).
- For E208e-p Controller:
 - Controller Based Encryption (CBE) with a remote key management server is not supported. Local key management (LKM) is supported.
 - One Button Secure Erase (OBSE) is used to sanitize drives, and factory reset the controller is not supported.
- For more information on the HPE Smart Array E208i-p SR Gen10 Controller, please refer to the [QuickSpecs](#)

Tri-mode RAID Controllers

HPE MR216i-o Gen11 x16 Lanes without Cache OCP SPDM Storage Controller P47789-B21

Notes:

- This is an OROC type controller which takes up an OCP slot.
- This controller supports up to 16 SAS/SATA/NVMe Drives (Only 4 x4 NVMe drives can be supported; eight x2 NVMe drives can be supported).

HPE MR408i-o Gen11 x8 Lanes 4GB Cache OCP SPDM Storage Controller P58335-B21

Notes:

- This is an OROC type controller which takes up an OCP slot.
- This controller supports up to 8 SAS/SATA/NVMe Drives (Only 2 x4 NVMe drives can be supported; four x2 NVMe drives can be supported).

HPE MR416i-o Gen11 x16 Lanes 8GB Cache OCP SPDM Storage Controller P47781-B21

Notes:

- This is an OROC type controller which takes up an OCP slot.
- This controller supports up to 16 SAS/SATA/NVMe Drives (Only 4 x4 NVMe drives can be supported; eight x2 NVMe drives can be supported).

HPE MR216i-p Gen11 x16 Lanes without Cache PCI SPDM Plug-in Storage Controller P47785-B21

Notes:

- This is a PCIe type controller which takes up a PCIe slot.
- This controller supports up to 16 SAS/SATA/NVMe Drives (Only 4 x4 NVMe drives can be supported; eight x2 NVMe drives can be supported).

HPE MR416i-p Gen11 x16 Lanes 8GB Cache PCI SPDM Plug-in Storage Controller P47777-B21

Notes:

- This is a PCIe type controller which takes up a PCIe slot.
- This controller supports up to 16 SAS/SATA/NVMe Drives (Only 4 x4 NVMe drives can be supported; eight x2 NVMe drives can be supported).

HPE SR932i-p Gen11 x32 Lanes 8GB Wide Cache PCI SPDM Plug-in Storage Controller P47184-B21

Notes:

- This is a PCIe type controller which takes up a PCIe slot.
- This controller supports up to 32 SAS/SATA/NVMe Drives (Only 8 x4 NVMe drives can be supported; 16 x2 NVMe drives can be supported).

Controller Battery Cable Kits

HPE Smart Storage Hybrid Capacitor with 260mm Cable Kit P02381-B21

HPE 96W Smart Storage Lithium-ion Battery with 260mm Cable Kit P01367-B21

HPE ProLiant DL3X5 Gen11 Smart Storage Battery 2P 96W Cable Kit P57884-B21

Notes:

- The two 260mm battery cable kit cannot be selected together.
- The Extension cable kit is required for either the selection of Hybrid Capacitor or 96W Smart Storage Battery

Core Options

HPE Drives

HDD Selection

Enterprise - 12G SAS - SFF Drives

HPE 2.4TB SAS 12G Mission Critical 10K SFF BC 3-year Warranty 512e Multi Vendor HDD	P28352-B21
HPE 1.2TB SAS 12G Mission Critical 10K SFF BC 3-year Warranty Multi Vendor HDD	P28586-B21
HPE 300GB SAS 12G Mission Critical 10K SFF BC 3-year Warranty Multi Vendor HDD	P40430-B21
HPE 600GB SAS 12G Mission Critical 10K SFF BC 3-year Warranty Multi Vendor HDD	P53561-B21
HPE 1.8TB SAS 12G Mission Critical 10K SFF BC 3-year Warranty 512e Multi Vendor HDD	P53562-B21
SED (Self-Encryption Drive)	
HPE 2.4TB SAS 12G Mission Critical 10K SFF BC 3yr Wty 512e FIPS 140-2 TAA-compliant HDD	P28618-B21
HPE 1.2TB SAS 12G Mission Critical 10K SFF BC 3yr Wty FIPS 140-2 TAA-compliant HDD	P28622-B21

Notes:

– Requirements for MR Tri-mode controller SED support.

- TPM is not required for Local Key Management as keys are stored in controller.
- iLO Advanced is required for Remote Key Management. Key is stored in remote key manager (Ex. SKM).

SSD Selection

Read Intensive - 6G SATA - SFF - Solid State Drives

HPE 240GB SATA 6G Read Intensive SFF BC Multi Vendor SSD	P40496-B21
HPE 480GB SATA 6G Read Intensive SFF BC Multi Vendor SSD	P40497-B21
HPE 480GB SATA 6G Read Intensive SFF BC PM893a SSD	P63886-B21
HPE 480GB SATA 6G Read Intensive SFF BC Self-encrypting 5400P SSD	P58236-B21
HPE 960GB SATA 6G Read Intensive SFF BC Multi Vendor SSD	P40498-B21
HPE 1.92TB SATA 6G Read Intensive SFF BC Multi Vendor SSD	P40499-B21
HPE 3.84TB SATA 6G Read Intensive SFF BC Multi Vendor SSD	P40500-B21
HPE 3.84TB SATA 6G Read Intensive SFF BC PM893a SSD	P63910-B21
HPE 7.68TB SATA 6G Read Intensive SFF BC Multi Vendor SSD	P40501-B21

Read Intensive - 12G & 24G SAS - SFF - Solid State Drives

HPE 960GB SAS 12G Read Intensive SFF BC Value SAS Multi Vendor SSD	P40506-B21
HPE 960GB SAS 24G Read Intensive SFF BC Multi Vendor SSD	P49029-B21
HPE 1.92TB SAS 12G Read Intensive SFF BC Value SAS Multi Vendor SSD	P40507-B21
HPE 1.92TB SAS 24G Read Intensive SFF BC Multi Vendor SSD	P49031-B21
HPE 3.84TB SAS 12G Read Intensive SFF BC Value SAS Multi Vendor SSD	P40508-B21
HPE 3.84TB SAS 24G Read Intensive SFF BC Multi Vendor SSD	P49035-B21
HPE 3.84TB SAS Read Intensive SFF BC Self-encrypting FIPS 140-2 PM7 SSD	P63875-B21
HPE 3.84TB SAS Read Intensive SFF BC Self-encrypting FIPS 140-3 PM7 SSD	P83347-B21
HPE 7.68TB SAS 12G Read Intensive SFF BC Value SAS Multi Vendor SSD	P40509-B21
HPE 7.68TB SAS 24G Read Intensive SFF BC Multi Vendor SSD	P49041-B21
HPE 15.36TB SAS 24G Read Intensive SFF BC Multi Vendor SSD	P49045-B21

Mixed Use - 12G SAS - SFF - Solid State Drives

HPE 800GB SAS 24G Mixed Use SFF BC Multi Vendor SSD	P49047-B21
HPE 960GB SAS 12G Mixed Use SFF BC Value SAS Multi Vendor SSD	P40510-B21
HPE 1.6TB SAS 24G Mixed Use SFF BC Multi Vendor SSD	P49049-B21
HPE 1.6TB SAS Mixed Use SFF BC Self-encrypting FIPS 140-2 PM7 SSD	P63871-B21
HPE 1.6TB SAS Mixed Use SFF BC Self-encrypting FIPS 140-3 PM7 SSD	P83344-B21
HPE 1.92TB SAS 12G Mixed Use SFF BC Value SAS Multi Vendor SSD	P40511-B21
HPE 3.2TB SAS 24G Mixed Use SFF BC Multi Vendor SSD	P49053-B21
HPE 3.84TB SAS 12G Mixed Use SFF BC Value SAS Multi Vendor SSD	P40512-B21
HPE 6.4TB SAS 24G Mixed Use SFF BC Multi Vendor SSD	P49057-B21

Mixed Use - 6G SATA - SFF - Solid State Drives

HPE 480GB SATA 6G Mixed Use SFF BC Multi Vendor SSD	P40502-B21
HPE 960GB SATA 6G Mixed Use SFF BC Multi Vendor SSD	P40503-B21
HPE 960GB SATA 6G Mixed Use SFF BC Self-encrypting 5400M SSD	P58244-B21

Core Options

HPE 1.92TB SATA 6G Mixed Use SFF BC Multi Vendor SSD	P40504-B21
HPE 3.84TB SATA 6G Mixed Use SFF BC Multi Vendor SSD	P40505-B21
Read Intensive - NVMe High Performance - SFF - Solid State Drives	
HPE 1.92TB NVMe Gen4 High Performance Read Intensive SFF BC U.3 PM1733a SSD	P50216-B21
HPE 1.92TB NVMe Gen4 High Performance Read Intensive SFF BC U.3 Self-encrypting FIPS 140-3 CM7 SSD	P61019-B21
HPE 3.84TB NVMe Gen4 High Performance Read Intensive SFF BC U.3 CM7 SSD	P63833-B21
HPE 3.84TB NVMe Gen4 High Performance Read Intensive SFF BC U.3 Self-encrypting FIPS 140-3 CM7 SSD	P61027-B21
HPE 3.84TB NVMe Gen4 High Performance Read Intensive SFF BC U.3 Static PM1753 SSD	P78806-B21
HPE 7.68TB NVMe Gen4 High Performance Read Intensive SFF BC U.3 PM1733a SSD	P50222-B21
HPE 7.68TB NVMe Gen4 High Performance Read Intensive SFF BC U.3 CM7 SSD	P63837-B21
HPE 7.68TB NVMe Gen4 High Performance Read Intensive SFF BC U.3 PS1010 SSD	P70434-B21
HPE 7.68TB NVMe Gen4 High Performance Read Intensive SFF BC U.3 Self-encrypting FIPS 140-3 CM7 SSD	P61035-B21
HPE 15.36TB NVMe Gen4 High Performance Read Intensive SFF BC U.3 PM1733a SSD	P50224-B21
HPE 15.36TB NVMe Gen4 High Performance Read Intensive SFF BC U.3 CM7 SSD	P63841-B21
HPE 15.36TB NVMe Gen4 High Performance Read Intensive SFF BC U.3 PS1010 SSD	P70436-B21
Read Intensive - NVMe Mainstream Performance - SFF - Solid State Drives	
HPE 3.84TB NVMe Gen4 Mainstream Performance Read Intensive SFF BC U.3 SPDM 7500 SSD	P84244-B21
HPE 3.84TB NVMe Gen4 Mainstream Performance Read Intensive SFF BC U.3 Static V2 Multi Vendor SSD	P64846-B21
HPE 7.68TB NVMe Gen4 Mainstream Performance Read Intensive SFF BC U.3 Static V2 Multi Vendor SSD	P64848-B21
HPE 7.68TB NVMe Gen4 Mainstream Performance Read Intensive SFF BC U.3 SPDM 7500 SSD	P84242-B21
HPE 15.36TB NVMe Gen4 Mainstream Performance Read Intensive SFF BC U.3 SPDM 7500b SSD	P84239-B21
Mixed Use - NVMe High Performance - SFF - Solid State Drives	
HPE 1.6TB NVMe Gen4 High Performance Mixed Use SFF BC U.3 PM1735a SSD	P50227-B21
HPE 1.6TB NVMe Gen4 High Performance Mixed Use SFF BC U.3 CM7 SSD	P63845-B21
HPE 1.6TB NVMe Gen4 High Performance Mixed Use SFF BC U.3 Self-encrypting FIPS 140-3 CM7 SSD	P61043-B21
HPE 3.2TB NVMe Gen4 High Performance Mixed Use SFF BC U.3 CM7 SSD	P63849-B21
HPE 3.2TB NVMe Gen4 High Performance Mixed Use SFF BC U.3 PS1030 SSD	P70426-B21
HPE 3.2TB NVMe Gen4 High Performance Mixed Use SFF BC U.3 Self-encrypting FIPS 140-3 CM7 SSD	P61051-B21
HPE 3.2TB NVMe Gen4 High Performance Mixed Use SFF BC U.3 Static PM1755 SSD	P78801-B21
HPE 3.2TB NVMe Gen5 High Performance Mixed Use E3.S EC1 PM1755 SSD	P78784-B21
HPE 6.4TB NVMe Gen4 High Performance Mixed Use SFF BC U.3 CM7 SSD	P63853-B21
HPE 6.4TB NVMe Gen4 High Performance Mixed Use SFF BC U.3 PS1030 SSD	P70428-B21
HPE 6.4TB NVMe Gen4 High Performance Mixed Use SFF BC U.3 Self-encrypting FIPS 140-3 CM7 SSD	P61059-B21
HPE 6.4TB NVMe Gen4 High Performance Mixed Use SFF BC U.3 Static PM1755 SSD	P78804-B21
HPE 6.4TB NVMe Gen5 High Performance Mixed Use E3.S EC1 PM1755 SSD	P78787-B21
Mixed Use - NVMe Mainstream Performance - SFF - Solid State Drives	
HPE 6.4TB NVMe Gen4 Mainstream Performance Mixed Use SFF BC U.3 Static V2 Multi Vendor SSD	P65023-B21
Mixed Use - NVMe Mainstream Performance - EDSFF E3.S - Solid State Drives	
HPE 1.6TB NVMe Gen5 Mainstream Performance Mixed Use E3S EC1 CD8P SSD	P69241-B21
HPE 1.6TB NVMe Gen5 Mainstream Performance Mixed Use E3S EC1 EDSFF SPDM PE1030 SSD	P77262-B21
HPE 3.2TB NVMe Gen5 Mainstream Performance Mixed Use E3S EC1 CD8P SSD	P69243-B21
HPE 3.2TB NVMe Gen5 Mainstream Performance Mixed Use E3S EC1 EDSFF SPDM PE1030 SSD	P77265-B21
HPE 6.4TB NVMe Gen5 Mainstream Performance Mixed Use E3S EC1 CD8P SSD	P69245-B21
HPE 6.4TB NVMe Gen5 Mainstream Performance Mixed Use E3S EC1 EDSFF SPDM PE1030 SSD	P77267-B21
Read Intensive - NVMe Mainstream Performance - EDSFF E3.S - Solid State Drives	
HPE 1.92TB NVMe Gen5 Mainstream Performance Read Intensive E3S EC1 CD8P SSD	P69234-B21
HPE 1.92TB NVMe Gen5 Mainstream Performance Read Intensive E3S EC1 EDSFF SPDM PE1010 SSD	P77269-B21
HPE 3.84TB NVMe Gen5 Mainstream Performance Read Intensive E3S EC1 EDSFF SPDM PE1010 SSD	P77271-B21
HPE 15.36TB NVMe Gen5 Mainstream Performance Read Intensive E3S EC1 CD8P SSD	P69546-B21
HPE 15.36TB NVMe Gen5 Mainstream Performance Read Intensive E3S EC1 EDSFF SPDM PE1010 SSD	P77275-B21
Read Intensive - NVMe High Performance - EDSFF E3.S - Solid State Drives	
HPE 3.84TB NVMe Gen5 High Performance Read Intensive E3S EC1 EDSFF SPDM CM7 SSD	P61179-B21
HPE 3.84TB NVMe Gen5 High Performance Read Intensive E3S EC1 EDSFF SPDM PM1743 SSD	P57799-B21
HPE 3.84TB NVMe Gen5 High Performance Read Intensive E3S EC1 PS1010 SSD	P70392-B21

Core Options

HPE 7.68TB NVMe Gen5 High Performance Read Intensive E3S EC1 EDSFF SPDM CM7 SSD	P61183-B21
HPE 7.68TB NVMe Gen5 High Performance Read Intensive E3S EC1 PS1010 SSD	P70395-B21
HPE 7.68TB NVMe Gen5 High Performance Read Intensive E3S EC1 Self-encrypting FIPS 140-3 CM7 SSD	P70674-B21
HPE 15.36TB NVMe Gen5 High Performance Read Intensive E3S EC1 EDSFF SPDM CM7 SSD	P61187-B21
HPE 15.36TB NVMe Gen5 High Performance Read Intensive E3S EC1 EDSFF SPDM PM1743 SSD	P57807-B21
HPE 15.36TB NVMe Gen5 High Performance Read Intensive E3S EC1 PS1010 SSD	P70397-B21
Very Read Intensive - NVMe Mainstream Performance - EDSFF E3.S - Solid State Drives	
HPE 3.84TB NVMe Gen4 Mainstream Performance Very Read Optimized E3S EC1 EDSFF P5430 SSD	P63930-B21
HPE 7.68TB NVMe Gen4 Mainstream Performance Very Read Optimized E3S EC1 EDSFF P5430 SSD	P63934-B21
HPE 15.36TB NVMe Gen4 Mainstream Performance Very Read Optimized E3S EC1 EDSFF P5430 SSD	P63938-B21
HPE 30.72TB NVMe Gen4 Mainstream Performance Very Read Optimized E3S EC1 EDSFF P5430 SSD	P79065-B21
Mixed Use - NVMe High Performance - EDSFF E3.S - Solid State Drives	
HPE 3.2TB NVMe Gen5 High Performance Mixed Use E3S EC1 EDSFF SPDM CM7 SSD	P61191-B21
HPE 3.2TB NVMe Gen5 High Performance Mixed Use E3S EC1 PS1030 SSD	P70399-B21
HPE 6.4TB NVMe Gen5 High Performance Mixed Use E3S EC1 Self-encrypting FIPS 140-3 CM7 SSD	P70672-B21
HPE 6.4TB NVMe Gen5 High Performance Mixed Use E3S EC1 PS1030 SSD	P70401-B21
HPE 12.8TB NVMe Gen5 High Performance Mixed Use E3S EC1 PS1030 SSD	P70403-B21

HPE Computation and Graphics Accelerator and related option kits

NVIDIA A16 64GB PCIe Non-CEC Accelerator for HPE	R8T26C
NVIDIA L4 24GB PCIe Accelerator for HPE	S0K89C
HPE ProLiant DL365 Gen11 CPU 8-pin GPU Power Cable Kit	P56919-B21

Notes:

- Supported with GPU CTO model only.
- If more than one quantity of Graphics option is selected, then part number must be same. Different Graphics option cannot be mixed within the server.
- NVIDIA L4 does not require Power Cable Kit.
- When NVIDIA A16 is selected, then "HPE DL365 Gen11 CPU 8p GPU Power Cable Kit" must be selected per Graphics Option.

HPE Tape Backup

For the complete range of tape drives, autoloaders, libraries and media see:

<https://www.hpe.com/us/en/storage/storeever-tape-storage.html>

For hardware and software compatibility of Hewlett Packard Enterprise tape backup products please visit the StoreEver Tape Solutions in SPOCK (requires registration/login) <https://h20272.www2.hpe.com/SPOCK/default.aspx>.

Only external drives are supported

All libraries and autoloaders supported via compatible FC or SAS controller. Refer to the StoreEver Tape Solutions Compatibility Matrix link above.

HPE Storage Options

Emulex Fibre Channel HBAs	
HPE SN1610E 32Gb 1-port Fibre Channel Host Bus Adapter	R2J62A
HPE SN1610E 32Gb 2-port Fibre Channel Host Bus Adapter	R2J63A
HPE SN1700E 64Gb 1-port Fibre Channel Host Bus Adapter	R7N77A
HPE SN1700E 64Gb 2-port Fibre Channel Host Bus Adapter	R7N78A
QLogic Fibre Channel HBAs	
HPE SN1610Q 32Gb 1-port Fibre Channel Host Bus Adapter	R2E08A
HPE SN1610Q 32Gb 2-port Fibre Channel Host Bus Adapter	R2E09A
HPE SN1700Q 64Gb 1-port Fibre Channel Host Bus Adapter	R7N86A
HPE SN1700Q 64Gb 2-port Fibre Channel Host Bus Adapter	R7N87A

HPE Networking

Core Options

1 Gigabit Ethernet adapters	
Intel I350-T4 Ethernet 1Gb 4-port BASE-T Adapter for HPE	P21106-B21
Broadcom BCM5719 Ethernet 1Gb 4-port BASE-T Adapter for HPE	P51178-B21
10 Gigabit Ethernet adapters	
Broadcom BCM57416 Ethernet 10Gb 2-port BASE-T Adapter for HPE	P26253-B21
Broadcom BCM57412 Ethernet 10Gb 2-port SFP+ Adapter for HPE	P26259-B21
10/25 Gigabit Ethernet adapters	
Broadcom BCM57414 Ethernet 10/25Gb 2-port SFP28 Adapter for HPE	P26262-B21
Broadcom BCM57504 Ethernet 10/25Gb 4-port SFP28 Adapter for HPE	P26264-B21
Intel E810-XXVDA2 Ethernet 10/25Gb 2-port SFP28 Adapter for HPE	P08443-B21
Mellanox MCX631102AS-ADAT Ethernet 10/25Gb 2-port SFP28 Adapter for HPE	P42044-B21
Intel E810-XXVDA4 Ethernet 10/25Gb 4-port SFP28 Adapter for HPE	P08458-B21
NVIDIA Ethernet 10/25Gb 2-port SFP28 NVMe-oF Crypto Adapter for HPE	S2A69A
100/200 Gigabit Ethernet adapters	
NVIDIA Ethernet 100Gb 2-port NVMe-oF Offload Adapter for HPE	R8M41A
Mellanox MCX623106AS-CDAT Ethernet 100Gb 2-port QSFP56 Adapter for HPE	P25960-B21
Intel E810-CQDA2 Ethernet 100Gb 2-port QSFP28 Adapter for HPE	P21112-B21

Notes:

- Almost all PCIe Networking Cards need 7x Performance Fans. Refer to OCA configurator for exceptions and details.
- Ambient temperature for above cards (P08458-B21, P25960-B21, P21112-B21, P10180-B21) is 25 °C under configuration of 8SFF SAS/SATA/NVMe/SAS4, with AOC (Active Optical Cables).
- Direct Attach Cable (DAC) for copper environments or fiber transceivers and cables for fiber-optic environments must be purchased separately. Refer to the related NIC QuickSpecs for Technical Specifications and additional information:
<https://h20195.www2.hpe.com/v2/getpdf.aspx/A00002507ENW.pdf>

OCP Adapter

1 Gigabit Ethernet OCP adapters	
Intel I350-T4 Ethernet 1Gb 4-port BASE-T OCP3 Adapter for HPE	P08449-B21
Broadcom BCM5719 Ethernet 1Gb 4-port BASE-T OCP3 Adapter for HPE	P51181-B21
10 Gigabit Ethernet OCP Adapters	
Broadcom BCM57412 Ethernet 10Gb 2-port SFP+ OCP3 Adapter for HPE	P26256-B21
Broadcom BCM57416 Ethernet 10Gb 2-port BASE-T OCP3 Adapter for HPE	P10097-B21
10/25 Gigabit Ethernet OCP adapters	
Broadcom BCM57414 Ethernet 10/25Gb 2-port SFP28 OCP3 Adapter for HPE	P10115-B21
Broadcom BCM57504 Ethernet 10/25Gb 4-port SFP28 OCP3 Adapter for HPE	P26269-B21
Intel E810-XXVDA2 Ethernet 10/25Gb 2-port SFP28 OCP3 Adapter for HPE	P10106-B21
Mellanox MCX631432AS-ADAI Ethernet 10/25Gb 2-port SFP28 OCP3 Adapter for HPE	P42041-B21
100/200 Gigabit Ethernet adapters	
Intel E810-CQDA2 Ethernet 100Gb 2-port QSFP28 OCP3 Adapter for HPE	P22767-B21

Notes:

- Almost all PCIe Networking Cards need 7x Performance Fans. Refer to OCA configurator for exceptions and details.
- P22767-B21 and P26269-B21 needs selection of an OCP upgrade cable kit.
- Ambient temperature for above cards (P26269-B21) is 25C under configuration of 8SFF SAS/SATA/NVMe/SAS4, with AOC (Active Optical Cables).
- P22767-B21 not allowed to select under configuration of 8SFF SAS/SATA/NVMe/SAS4, with AOC (Active Optical Cables).
- Ambient temperature for above cards (P22767-B21) is 25C under configuration of 8SFF SAS/SATA/NVMe/SAS4, with Direct Attach Cable (DAC).

HPE InfiniBand

Core Options

HPE InfiniBand NDR200/Ethernet 200Gb 1-port OSFP PCIe5 x16 MCX75310AAS-HEAT Generic Adapter	P45642-H23
HPE InfiniBand NDR200/Ethernet 200GbE 2-port QSFP112 PCIe5 x16 MCX755106AC-HEAT Adapter	P65333-H21
HPE InfiniBand NDR/Ethernet 400Gb 1-port OSFP PCIe5 x16 MCX75310AAS-NEAT Adapter	P45641-H23

Notes:

- InfiniBand NDR 200Gb/400Gb requires Performance Heatsink or DLC module and 7 performance fan kits.
- If InfiniBand NDR 200Gb/400Gb (P45642-H23/P45641-H23) is selected, 256GB Memory is limited to 12 quantity. This restriction is not applicable to DLC Module
- If InfiniBand NDR 200Gb/400Gb (P45642-H23/P45641-H23) is selected, 8SFF CTO model is restricted to 6 quantity of SFF drives
- For more information, please visit: [HPE InfiniBand Options for HPE ProLiant and Apollo Servers](#)

HPE ProLiant DL3X5 Gen11 x16 OCP1 1P Upgrade Cable Kit	P57882-B21
--	------------

Notes:

- This cable kit cannot be selected when 2 processors are configured.
- This cable kit upgrades OCP1 from x8 to x16.
- When this kit is selected, max of 1 OCP card can be selected per server.

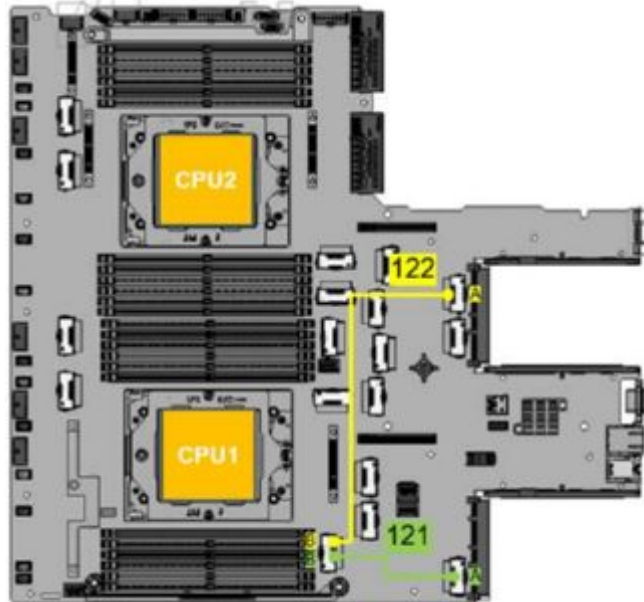

HPE ProLiant DL3X5 Gen11 x16 OCP1 OCP2 2P Upgrade Cable Kit	P57849-B21
---	------------

Notes:

- This cable kit needs 2 configured processors.
- This cable kit upgrades OCP1 from x8 to x16 and OCP2 from x8 to x16.
- When this cable kit is selected then the Secondary Riser Upgrade Kit cannot be configured.
- When this cable kit is selected then 8SFF x4 U.3 Mid Cage cannot be supported with Direct Attach.

Core Options

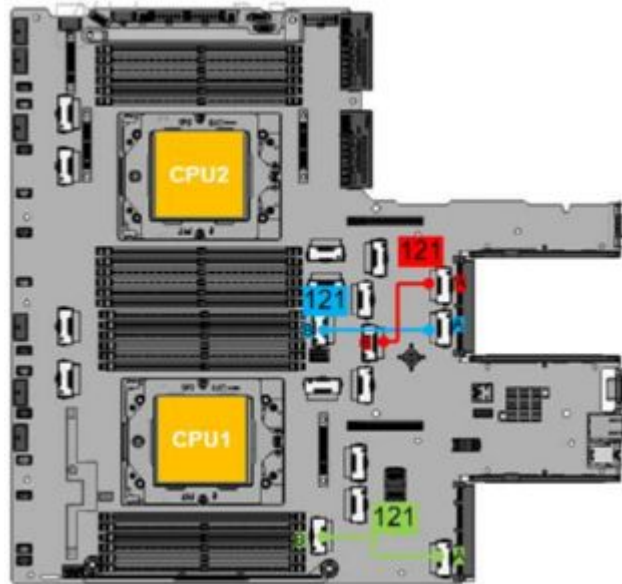

HPE Power Supplies

HPE Flexible Slot (Flex Slot) Power Supplies share a common electrical and physical design that allows for hot-plug, tool-less installation into HPE ProLiant Gen11 Servers. Flex Slot power supplies are certified for high-efficiency operation and offer multiple power output options, allowing users to "right-size" a power supply for specific server configurations. This flexibility helps to reduce power waste, lower overall energy costs, and avoid "trapped" power capacity in the data center.

Notes:

- Prior to making a power supply selection it is highly recommended that the HPE Power Advisor is run to determine the right size power supply for your server configuration. The HPE Power Advisor is located at:

<https://poweradvisorex.it.hpe.com/?Page=Index>

- HPE ProLiant servers ship with an IEC-IEC power cord used for rack mounting with Power Distribution Units (PDUs). Visit [HPE Power Cords and Cables](#) for a full list of optional power cords.

HPE 800W Flex Slot Platinum Hot-plug Low Halogen Power Supply Kit

P38995-B21

HPE 1000W Flex Slot Titanium Hot-plug Power Supply Kit

P03178-B21

Notes: Flex Slot Platinum Plus power supplies support power efficiency of up to 94% and include a C-14 power inlet connector that can support HPE Power Discovery Services (blue connector).

HPE 1600W Flex Slot -48VDC Hot-plug Power Supply Kit

P17023-B21

Notes:

- Flex Slot universal power supplies support power efficiency of up to 94% and support both 277VAC/380VDC power inputs.
- HPE 1600W DC PSU Power Lug Option Kit (P36877-B21) must be selected along with this power supplies.

HPE 1600W Flex Slot Platinum Hot-plug Low Halogen Power Supply Kit

P38997-B21

Notes:

- Flex Slot Platinum Plus power supplies support power efficiency of up to 94% and include a C-14 power inlet connector that can support HPE Power Discovery Services (blue connector).
- The power supply selected only supports high line voltage (200VAC to 240VAC)

HPE 1800W-2200W Flex Slot Titanium Hot-plug Power Supply Kit

P44712-B21

Notes:

- Flex Slot Titanium power supplies support power efficiency of up to 96% and include a C-14 power inlet connector that can support HPE Power Discovery Services (blue connector).
- The power supply selected only supports high line voltage (200VAC to 240VAC)

HPE 1600W -48VDC Power Cable Lug Kit

P36877-
B21

Notes: Must be selected along with HPE 1600W Flex Slot -48VDC Hot-plug Power Supply Kit (P17023-B21).

Additional Options

Some options may not be integrated at the factory. To ensure only valid configurations are ordered, Hewlett Packard Enterprise recommends the use of an HPE approved configurator. Contact your local sales representative for additional information.

Cable Kits

HPE ProLiant DL365 Gen11 XGMI Interconnection Cable Kit P63125-B21

Notes:

- Maximum quantity of 1 can be selected per system.
- If selected, then 2 processors must be selected.
- Supported with 8SFF CTO model only.

HPE ProLiant DL365 Gen11 8SFF OROC x1 SAS/SATA/NVMe Cable Kit P56901-B21

Notes:

- Maximum quantity of 1 can be selected per system.
- This cable kit supports the HPE DL365 G11 8SFF TM U.3 x1 FIO Backplane Kit and an OROC storage controller.

HPE ProLiant DL365 Gen11 8SFF x1 SAS/SATA/NVMe PCIe Cable Kit P56903-B21

Notes:

- Maximum quantity of 1 can be selected per system.
- This cable kit supports the HPE DL365 G11 8SFF TM U.3 x1 FIO Backplane Kit and a PCIe storage controller.

HPE ProLiant DL365 Gen11 2SFF OROC x1 SAS/SATA Cable Kit P56905-B21

Notes:

- Maximum quantity of 1 can be selected per system.
- This cable kit supports below backplane kits:
- HPE DL365 G11 2SFF TM U.3 x4 Bal BP Kit.

HPE ProLiant DL365 Gen11 2SFF x1 SAS/SATA PCIe Cable Kit P56907-B21

Notes:

- Maximum quantity of 1 can be selected per system.
- This cable kit supports below backplane kits.
- HPE DL365 G11 2SFF TM U.3 x4 Bal BP Kit.

HPE ProLiant DL365 Gen11 2SFF SATA Direct Attach Cable Kit P56909-B21

Notes:

- Maximum quantity of 1 can be selected per system.
- This cable kit only supports the HPE DL365 G11 2SFF TM U.3 x4 Bal Backplane Kit.

HPE ProLiant DL365 Gen11 8SFF x4 Tri-Mode PCIe Cable Kit P56911-B21

Notes:

- Maximum quantity of 1 can be selected per system.
- This cable kit supports below backplane kits.
- HPE DL365 G11 8SFF TM U.3 x4 Bal BP Kit.

HPE ProLiant DL365 Gen11 8SFF OROC Tri-Mode Splitter Cable Kit P56913-B21

Notes:

- Maximum quantity of 1 can be selected per system.
- This cable kit supports connection with an 8SFF Tri-mode U.3 x4 backplane and an OROC controller.

HPE ProLiant DL365 Gen11 8SFF NVMe Direct Attach Balanced Cable Kit P56917-B21

HPE ProLiant DL365 Gen11 2SFF NVMe Direct Attach Balanced Cable Kit P56918-B21

Notes: The 8SFF and 2SFF NVMe Direct Attach Balance Cable kits support direct attach for the NVMe drives on the 8SFF and 2SFF TM backplanes.

Additional Options

HPE ProLiant DL36X Gen11 Rear Serial Port Cable Kit	P59431-B21
HPE ProLiant DL365 Gen11 GPU 4SFF x4 OCP Tri-Mode Cable Kit	P69876-B21
HPE ProLiant DL3X5 Gen11 GPU 4SFF x4 PCIe Tri-Mode Cable Kit	P70318-B21

Notes: [GPU CTO](#)

- Maximum 1 Quantity of GPU 4SFF Cable kit can be selected.
- If P69876-B21 is selected, then 4SFF x4 U.3 Drive Cage and MR416i-o controller must be selected.
- If P70318-B21 is selected, then 4SFF x4 U.3 Drive Cage and MR416i-p controller must be selected.

HPE ProLiant DL365 Gen11 GPU 8EDSFF x4 PCIe Tri-Mode Cable Kit	P69874-B21
--	------------

Notes:

- Supported with CPU CTO model only.
- Maximum 1 of anyone (not all) of the following cable kit can be selected (HPE DL365 Gen11 GPU 8EDSFF PCIe Tri-Mode Cable Kit, HPE DL365 Gen11 GPU 4SFF x4 OCP Tri-Mode Cable Kit, or HPE DL3x5 Gen11 GPU 4SFF x4 Tri-Mode Cable Kit).

- If P69874-B21 is selected, then SR932i-p controller must be selected.

HPE ProLiant DL3X5 Gen11 16EDSFF x2 PCIe Tri-Mode Cable Kit	P69878-B21
---	------------

Notes:

- Supported for EDSFF CTO model only.
- Maximum 1 quantity of cable kit can be selected.
- If P69878-B21 is selected, then SR932i-p controller must be selected.

HPE Racks

- Refer to the HPE Advanced Series Racks QuickSpecs for information on additional racks options and rack specifications. [HPE G2 Advanced Series Racks](#)
- Refer to the HPE Enterprise Series Racks QuickSpecs for information on additional racks options and rack specifications. [HPE G2 Enterprise Series Racks](#)

HPE Power Distribution Units (PDUs)

- Refer to the [HPE Basic Power Distribution Units \(PDU\) QuickSpecs](#) for information on these products and their specifications.
- Refer to the [HPE Metered Power Distribution Units \(PDU\) QuickSpecs](#) for information on these products and their specifications. Refer to the [HPE Intelligent Power Distribution Unit \(PDU\) QuickSpecs](#) for information on these products and their specifications.
- Refer to the [HPE Metered and Switched Power Distribution Units \(PDU\) QuickSpecs](#) for information on these products and their specifications.

HPE Uninterruptible Power Systems (UPS)

- To learn more, please visit the [HPE Uninterruptible Power Systems \(UPS\) web page](#).
- Refer to the [HPE DirectFlow Three Phase Uninterruptible Power System QuickSpecs](#) for information on these products and their specifications.
- Refer to the [HPE Line Interactive Single Phase UPS QuickSpecs](#) for information on these products and their specifications.

HPE Support Services Installation & Start-up Services

Installation Services

HPE ProLiant DL/ML Install Service	U4554E
HPE ProLiant DL/ML Startup Service	U4555E

Additional Options

Tech Care

HPE 3 Year Tech Care Essential DL365 Gen11 Service	H79C4E
HPE 3 Year Tech Care Essential wDMR DL365 Gen11 Service	H79C5E
HPE 5 Year Tech Care Essential DL365 Gen11 Service	H79E8E
HPE 5 Year Tech Care Essential wDMR DL365 Gen11 Service	H79E9E

Notes: For a full listing of support services available for this server, please visit <http://www.hpe.com/services>

Memory

Memory Population guidelines

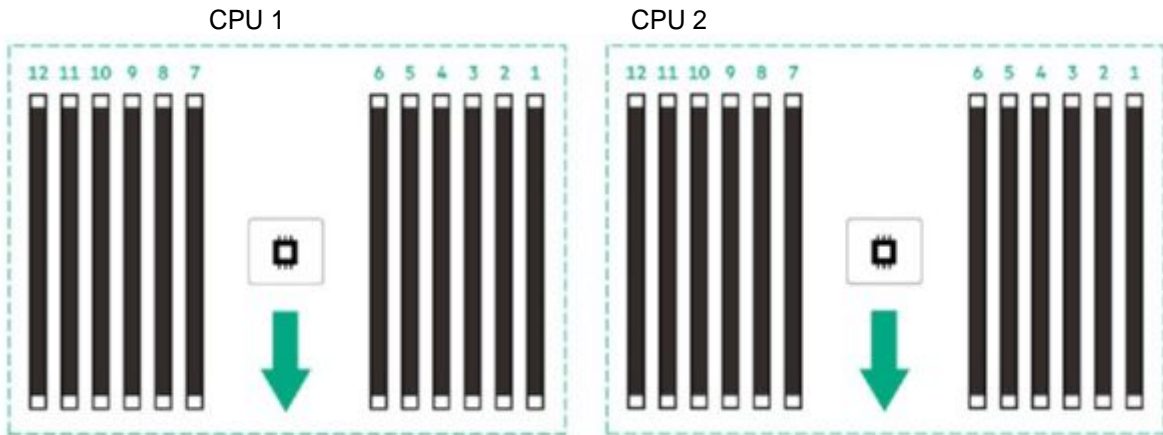

Front side of the server

General Memory Population Rules and Guidelines

- Install DIMMs only if the corresponding processor is installed.
- If only one processor is installed in a two-processor system, only half of the DIMM slots are available.
- To maximize performance, it is recommended to balance the total memory capacity between all installed processors.
- When two processors are installed, balance the DIMMs across the two processors.
- The maximum memory speed is a function of the memory type, memory configuration, and processor model.
- The maximum memory capacity is a function of the number of DIMM slots on the platform, the largest DIMM capacity qualified on the platform, the number and model of installed processors qualified on the platform.
- To realize the performance memory capabilities listed in this document, HPE DDR5 Smart Memory is required. For additional information, refer to the: [HPE DDR5 Smart Memory QuickSpecs](#)
- For General Server Memory and Persistent Memory Population Rules and Guidelines, see details here: https://support.hpe.com/hpesc/public/docDisplay?docId=sd00002129en_us
- For details on the HPE Server Memory speed, visit: [Server memory population rules for HPE ProLiant Gen11 servers with AMD EPYC™ 9004 series processors](#)

Storage

8 SFF device bay numbering



8 SFF + 2 SFF device bay numbering



20 EDSFF device bay numbering - E.3S



GPU Server with 8 EDSFF (image shows both 2 single-wide and 2 double-wide GPU scenarios)

Memory



Technical Specifications

System Unit

Dimensions (Height x Width x Depth)

- SFF: 4.29 X 44.89 X 64.94 cm; 1.69 X 17.67 X 25.57 in
- EDSFF: 4.29 X 44.88 X 70.89 cm; 1.69 X 17.67 X 27.91 in
- GPU: 4.29 X 44.88 X 81.83 cm; 1.69 X 17.67 X 32.22 in
- Packaging

- SFF: 91.6 X 60.0 X 24.2 cm; 36.06 X 23.63 X 9.53 in
- EDSFF: 91.6 X 60.0 X 24.2 cm; 36.06 X 23.63 X 9.53 in
- GPU: 100.1 X 60.0 X 24.2 cm; 39.41 X 23.63 X 9.53 in

Weight (approximate)

– SFF Configuration

- Minimum 12.70 kg / 27.94 lb. 8 SFF chassis with 8 HDD blanks, 2x Drive Bay blanks, 1x CPU including standard heat sink, 2x DIMMs, 5x FANs (40x40x56), 2x blank FANs, 1x power supply plus blank, 1x Smart Array, 1x Riser installed, cables for the above

Package weight: 24.36 kg; 53.7 lb.

- Maximum 18.39 kg / 40.46 lb. 10x SFF chassis with 10 HDD blanks, 2x CPUs, 2 heat sinks, 2x power supplies, 1x Smart Array, 2x Risers installed, 16x DIMMs, 7x FANs (40x40x56), 1x Megacell Battery, cables for the above

Package weight: 29.36 kg; 64.73 lb.

– EDSFF Configuration

- Minimum 13.10 kg / 28.88 lb. 1x1T EDSFF, 19x EDSFF blank, 1x CPU, 1x CPU including standard heat sink, 2x DIMMs, 5x FANs (40x40x56), 2x blank FANs, 1x Primary Full Height Riser Cage, 1x power supply plus blank, 1x 1U Full Height Riser Card, 1x Full Height add-in card, 1x PCIe blank, cables for the above

Package weight: 21.87 kg / 48.21 lb.

- Maximum 19.00 kg / 41.89 lb. 20x EDSFF blank, 2x CPU, 2x CPU including performance heatsink, 24x DIMMs, 7x FANs (40x40x56), 1x Megacell Battery, 2x Primary Full Height Riser Cage, 2x power supply, 1x 1U Full Height Riser Card, 1x Full Height add-in card, cables for the above

Package weight: 28.18 kg / 62.13 lb.

– GPU Configuration

- Minimum 16.90 kg / 37.26 lb. 1x 1T EDSFF, 7x EDSFF blank, 1x Double Wide GPU, 1x SFF, 3x SFF blank, 1x CPU, 1x CPU including standard heatsink, 2x DIMMs, 5x FANs (40x40x56), 2x blank FANs, 1x Primary Full Height Riser Cage, 1x power supply plus blank, 1x 1U Full Height Riser Card, 1x Full Height add-in card, 1x PCIe blank, cables for the above

Package weight: 27.6 kg / 60.85 lb.

- Maximum 22.90 kg / 50.49 lb. 8x 1T EDSFF, 2x Double Wide GPU, 2x CPU, 2x CPU including performance heatsink, 24x DIMMs, 7x FANs (40x40x56), 1x Megacell Battery, 2x Primary Full Height Riser Cage, 2x power supply, 1x 1U Full Height Riser Card, 1x Full Height add-in card, cables for the above

Package weight: 34.68 kg / 76.46 lb.

Input Requirements (per power supply)

Rated Line Voltage

- 100 to 120 VAC
 - 200 to 240 VAC
-

BTU Rating

Maximum

Technical Specifications

- For 1600W Power Supply: 5918 BTU/hr. (at 200 VAC), 5884 BTU/hr. (at 240 VAC) for China
- For 800W Power Supply: 3207 BTU/hr. (at 100 VAC), 3071 BTU/hr. (at 200 VAC), 3112 BTU/hr. (at 240 VAC) for China Only
- For 500W Power Supply: 1979 BTU/hr. (at 100 VAC), 1911 BTU/hr. (at 200 VAC), 1965 BTU/hr. (at 240 VAC) for China Only

Power Supply Output (per power supply)

- Rated Steady-State Power
 - For 1600W Power Supply: 1600W (at 240 VAC), 1600W (at 240 VAC)
 - For 800W Power Supply: 800W (at 100 VAC), 800W (at 240 VAC), 800W (at 240 VAC) input for China only
 - For 500W Power Supply: 500W (at 100 VAC), 500W (at 240 VAC), 500W (at 240 VAC) input for China only
- Maximum Peak Power
 - For 1600W Power Supply: 1600W (at 200 to 240 1VAC), 1600W (at 240 VAC) input for China only
 - For 800W Power Supply: 800W (at 100 to 127 VAC), 800W (at 200 to 240 1VAC), 800W (at 240 VAC) input for China only
 - For 500W Power Supply: 500W (at 100 to 127 VAC), 500W (at 200 to 240 VAC), 500W (at 240 VAC) input for China only

System Inlet Temperature

- Standard Operating Temperature

10° to 35°C (50° to 95°F) at sea level with an altitude derating of 1.0°C per every 305 m (1.8°F per every 1000 ft.) above sea level to a maximum of 3050 m (10,000 ft.), no direct sustained sunlight. Maximum rate of change is 10°C/hr. (18°F/hr.). The upper limit and rate of change may be limited by the type and number of options installed. System performance during standard operating support may be reduced if operating with a fan fault or above 30°C (86°F).
- Extended Ambient Operating Temperature

For approved hardware configurations, the supported system inlet range is extended to be: 5° to 10°C (41° to 50°F) and 35° to 40°C (95° to 104°F) at sea level with an altitude derating of 1.0°C per every 175 m (1.8°F per every 574 ft.) above 900 m (2953 ft.) to a maximum of 3050 m (10,000 ft.). The approved hardware configurations for this system are listed at the URL: <https://www.hpe.com/support/ASHRAEGen11>

For approved hardware configurations, the supported system inlet range is extended to be: 40° to 45°C (104° to 113°F) at sea level with an altitude derating of 1.0°C per every 125 m (1.8°F per every 410 ft.) above 900 m (2953 ft.) to a maximum of 3050 m (10,000 ft.). The approved hardware configurations for this system are listed at the URL: <https://www.hpe.com/support/ASHRAEGen11>

System performance may be reduced if operating in the extended ambient operating range or with a fan fault.
- Non-operating

-30° to 60°C (-22° to 140°F). Maximum rate of change is 20°C/hr. (36°F/hr.).

Relative Humidity (non-condensing)

- Operating

8% to 90% - Relative humidity (Rh), 28°C maximum wet bulb temperature, non-condensing.
- Non-operating

5 to 95% relative humidity (Rh), 38.7°C (101.7°F) maximum wet bulb temperature, non-condensing.

Altitude

- Operating

3050 m (10,000 ft.). This value may be limited by the type and number of options installed. Maximum allowable altitude change rate is 457 m/min (1500 ft./min).
- Non-operating

Technical Specifications

9144 m (30,000 ft.). Maximum allowable altitude change rate is 457 m/min (1500 ft./min).

Emissions Classification (EMC) - Regulatory Information

To view the regulatory information for your product, view the Safety and Compliance Information for Server, Storage, Power, Networking, and Rack Products, available at the Hewlett Packard Enterprise Support Center:

<http://www.hpe.com/support/Safety-Compliance-EnterpriseProducts>

HPE RAID Controllers

For latest information on HPE Gen11 RAID Controllers for HPE ProLiant DL Servers please refer to their QuickSpecs.

Environmentally friendly Products and Approach - End-of-life Management and Recycling

Hewlett Packard Enterprise offers [end-of-life product return, trade-in, and recycling programs](#), in many geographic areas, for our products. Products returned to Hewlett Packard Enterprise will be recycled, recovered or disposed of in a responsible manner.

The European Union Waste Electrical and Electronic Equipment Directive [EU WEEE] (2002/95/EC) requires manufacturers to provide treatment information for each product type for use by treatment facilities. This information (product disassembly instructions) is posted on the Hewlett Packard Enterprise web site. These instructions may be used by recyclers and other WEEE treatment facilities as well as Hewlett Packard Enterprise OEM customers who integrate and re-sell Hewlett Packard Enterprise equipment.

Acoustic Noise

Listed are the declared A-Weighted sound power levels ($L_{WA,d}$) and declared average bystander position A-Weighted sound pressure levels ($L_{pA,m}$) when the product is operating in a 23°C ambient environment. Noise emissions were measured in accordance with ISO 7779 (ECMA 74) and declared in accordance with ISO 9296 (ECMA 109). The listed sound levels apply to standard shipping configurations. Additional options may result in increased sound levels. Please have your HPE representative provide information from the HPE EMESC website for further technical details regarding the configurations listed below.

Idle	
LWAd	4.9 B Base
LpAm	35 dBA Base
Operating	
LWAd	5.9 B Base
LpAm	46 dBA Base

Notes:

- Acoustics levels presented here are generated by the test configuration only. Acoustics levels will vary depending on system configuration. Values are subject to change without notification and are for reference only.
- Product conformance to cited product specifications is based on sample (type) testing, evaluation, or assessment. This product or family of products is eligible to bear the appropriate compliance logos and statements.
- The Listed sound levels apply to standard shipping configurations. Additional options may result in increased sound levels.

Summary of Changes

Date	Version History	Action	Description of Change
06-Apr-2026	Version 40	Added	Updated memory section with new note and added new 246GB SKU Added new 3.2TB/6.4TB NVMe SSDs Added P65333-H21 IB NDR 200Gb 2-port Adapter
02-Mar-2026	Version 39	Changed Added	Service and Support section was updated. Updated GreenLake statement.
02-Feb-2026	Version 38	Changed Added Removed	Configuration Information and Core Options sections were updated. InfiniBand NDR/Ethernet 200Gb 1-port (P45642-H23). 4800 MT/s DDR5 DIMMs compatible with AMD EPYC™ 4th Generation CPUs obsolete SKU.
05-Jan-2026	Version 37	Changed Added Removed	Core Options section was updated. Missing InfiniBand NDR/Ethernet 400GB 1-port (P45641-H23) OBS SKUs InfiniBand HDR/Ethernet 100GB 2-port & 200GB 2-port
01-Dec-2025	Version 36	Changed Added Removed	Core Options section was updated. Smart Hybrid 16W controller cable and 12G SAS Read Intensive & Mixed Use SDDs SKUs. Read Intensive - NVMe Mainstream Performance - SFF - Solid State Drives obsolete SKU.
03-Nov-2025	Version 35	Changed Added Removed	Configuration Information and Core Options sections were updated. NVMe Mainstream Performance RI SSDs InfiniBand HDR/Ethernet 100GB 1-port, 200GB 2-port
09-Sept-2025	Version 34	Added	NVMe Mainstream Performance RI SFF SSDs
04-Aug-2025	Version 33	Changed Added	Core Options section was updated. HPE NS204i-u 960GB SKUs.
07-Jul-2025	Version 32	Changed	Core Options section was updated.
02-Jun-2025	Version 31	Changed	Core Options section was updated. Added new 30.72TB NVMe Performance SSD and HPE Compute Ops Management SKU.
05-May-2025	Version 30	Changed	Configuration Information and Additional Options sections were updated. Added: European Union ErP Lot 9 Regulation section to include Turkey and Ireland. Removed: HPE Converged Infrastructure Management Software SKUs.
07-Apr-2025	Version 29	Changed	Standard Features and Core Options sections were updated. Added the 1/3/5/7yr COM Advance SKUs and QuickSpecs survey. Updated select MR controller to reflect SPDM feature is now enabled with Turin
18-Mar-2025	Version 28	Changed	Standard Features section was updated. (AMD EPYC™ 9xx5 series now support 6400MT/s DIMM speed).
03-Mar-2025	Version 27	Changed	Overview, Configuration Information and Core Options sections were updated. Added new 256GB 3DS Smart Kit compatible with AMD EPYC™ 5th Gen CPU (P73446-B21).

Summary of Changes

Date	Version History	Action	Description of Change
03-Feb-2025	Version 26	Changed	Standard Features, Pre-Configured Models, Configuration Information and Core Options sections were updated. Added: New NVMe Read intensive E3S SSDs
06-Jan-2025	Version 25	Changed	Configuration Information section was updated. (Removed OBS'd 32GB single Rank DDR5-4800 Memory Kit)
02-Dec-2024	Version 24	Changed	Core Options section was updated. (Added: new NS204i-u v2 SKU Removed obsolete SSD drives)
04-Nov-2024	Version 23	Changed	Overview, Standard Features, Configuration Information and Core Options sections were updated. Overview updated to highlight 5 th Generation AMD EPYCTM CPU launch Added: New AMD EPYCTM 5 th Gen CPUs, memory SKUs, added notes in the applicable Storage Controllers sections
10-Oct-2024	Version 22	Changed	OS Certification information were updated.
26-Sep-2024	Version 21	Changed	Added: New GL COM 7yr SKU S2E10AAE
05-Aug-2024	Version 20	Changed	Overview and Core Option sections were updated. Added: new SSD (NVMe Gen5 Read Intensive/Mixed Used High Performance) SKUs. Added information regarding DLC to include images.
01-Jul-2024	Version 19	Changed	Standard Features, Configuration Information, Core Options, and Technical Specifications sections were updated. Updates: product dimension/weights details Added: new backplane (P71757-B21), rail kits (P69874-B21, P69878-B21) and SSD (NVMe Read Intensive/Mixed Used High Performance) SKUs.
03-Jun-2024	Version 18	Changed	Overview, Configuration Information, Core Options, and Technical Specifications sections were updated. Details below: Added Storage drive images, OCP1 and OCP2 cable image, and system unit details for EDSFF/GPU. Added missing 32GB memory SKU, GPU cable kit SKUs, and InfiniBand NDR200 adapter
20-May-2024	Version 17	Changed	Overview, Standard Features, Pre-Configured Models, Configuration Information and Core Options sections were updated.
22-Apr-2024	Version 16	Changed	Overview, Standard Features, Pre-Configured Models, Configuration Information and Core Options sections were updated. Updates: Standard features (overview, What's new, processor) sections, BTO SKU Part Numbers. Added: Processor table, Thermal Support matrix table, 128GB dual rank memory SKU (P69982-B21), Cable kits for GPU 4SSF (P69876-B21, P70318-B21), 6G & 12G SAS SATA SFF drives (P285861-B21, P40498-B21, P40499-B21), Read Intensive NVMe SFF SSDs, Mixed Use NVMe SFF SSDs and NVMe High Performance Read Intensive EDSFF E3.S SSDs, and NVMe Mainstream Performance Very Read Optimized SKUs Removed: Memory 32GB SRx4 SKU P50310-B21, 12G SAS SFF drives 1TB/ 2TB (P28505-B21, P53563-B21), 6G SATA SFF drives (P28610-B21, P28500-B21), and very Read Optimized SATA SFF (P58288-B21)

Summary of Changes

Date	Version History	Action	Description of Change
18-Mar-2024	Version 15	Changed	Standard Features, Core Options and Additional Options sections were updated.
08-Jan-2024	Version 14	Changed	Service and Support and Core Options sections were updated. (Added a new Riser Support Matrix in the Core Options section. Added new CM7 EDSFF E3.S 1T drives)
08-Jan-2024	Version 14	Changed	Service and Support and Core Options sections were updated. (Added a new Riser Support Matrix in the Core Options section. Added new CM7 EDSFF E3.S 1T drives)
04-Dec-2023	Version 13	Changed	Service and Support, Configuration Information and Core Options sections were updated.
02-Oct-2023	Version 12	Changed	Core Options section was updated.
05-Sep-2023	Version 11	Changed	Overview, Configuration Information, and Core Options sections were updated
07-Aug-2023	Version 10	Changed	Standard Features, Configuration Information, Core Options and Additional Options sections were updated
10-Jul-2023	Version 9	Changed	Standard Features, Service and Support, Core Options, and Technical Specifications sections were updated.
13-Jun-2023	Version 8	Changed	Standard Features, Service and Support, Pre-Configured Models, Configuration Information, Core Options, and Additional Options sections were updated
01-May-2023	Version 7	Changed	Standard Features and Core Options sections were updated.
03-Apr-2023	Version 6	Changed	Standard Features, Configuration Information and Technical Specifications sections were updated
06-Mar-2023	Version 5	Changed	Standard Features section was updated.
06-Feb-2023	Version 4	Changed	Overview, Standard Features, Configuration Information, additional Options and Technical Specifications sections were updated.
19-Dec-2022	Version 3	Changed	Standard Features section was updated.
05-Dec-2022	Version 2	Changed	Standard Features, Configuration Information, Core Options and Additional Options sections were updated.
10-Nov-2022	Version 1	New	New QuickSpecs

[Shape the Future of QuickSpecs - Your Input Matters](#)

Chat now

© Copyright 2026 Hewlett Packard Enterprise Development LP. The information contained herein is subject to change without notice. The only warranties for Hewlett Packard Enterprise products and services are set forth in the express warranty statements accompanying such products and services. Nothing herein should be construed as constituting an additional warranty. Hewlett Packard Enterprise shall not be liable for technical or editorial errors or omissions contained herein.

AMD® and EPYC® are registered trademarks of Advanced Micro Devices Corporation in the U.S. and other countries.

Microsoft®, Windows®, and Windows Server® are U.S. registered trademarks of the Microsoft group of companies.

a50004299enw - 16903 - Worldwide - V40 - 06-April-2026
HEWLETT PACKARD ENTERPRISE
HPE.com

